

The new underfloor trunking system tehalit.BK Broadway  
Invisible perfection

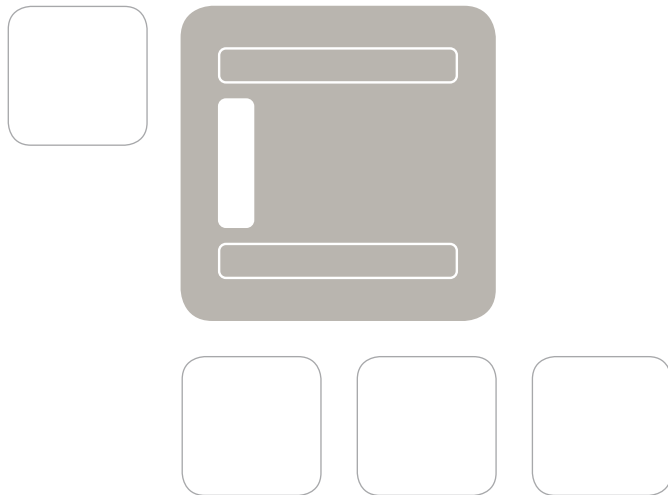

**Well prepared**  
with Hager  
wall-installation  
systems



**Ahead of their time:**  
with Hager  
ceiling-installation  
systems

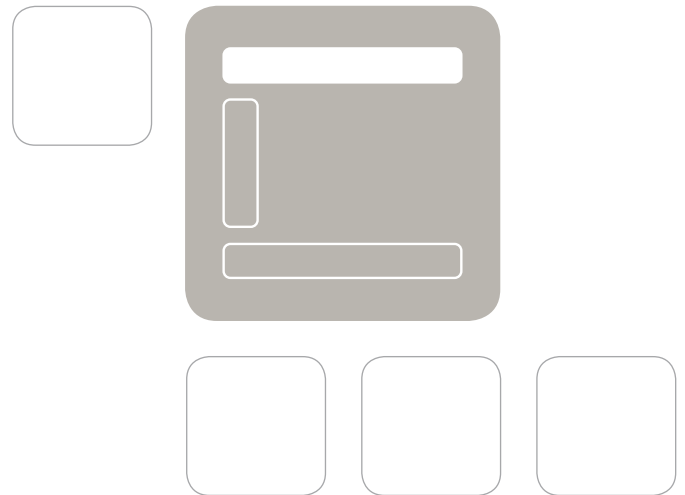

## Walls, ceilings, floors: Hager's all-round package

Electrical installations require a three-dimensional approach: optimal solutions that fulfill both technical and visual requirements can only be found once you look and think in all directions.

This has always been one of our strongest assets. As specialists for electrical installations in residential and commercial buildings, we tend to look up and down, left and right – but mainly ahead. Our conclusion: the ideal solution is a question of perspective. We have therefore developed

installation solutions for floors, walls and ceilings and dedicated separate brochures to these fields. They will give you room for ideas – open up!

**Well positioned**  
with Hager  
floor-installation  
systems

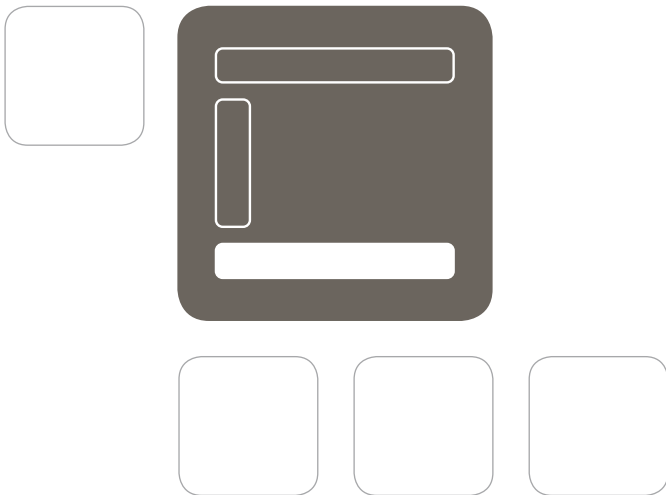

## All advantages at a glance

- Modern electrical infrastructure for old and new buildings
- Optimal wiring of the utilized area
- Cost-optimized basic installation
- Attractive interior design feature
- Highest degree of flexibility in expanding or changing existing systems
- Planning and assembly made easy

[www.hager.com](http://www.hager.com)



## Help your customers to stay ahead of the game!

The face of modern office architecture is shaped by large glass frontages whereas traditional external and internal walls are increasingly on their way out. This means that electrical engineers need to go ever further „underground“ if they are to set up a capable, high-performance electrical infrastructure.



**Better than ever: the new tehalit.BK broadband**

As part of ongoing improvements to Hager flooring systems, we have optimized our already successful solutions even further: for example, the underfloor trunking system is now even easier to install and even more practical to use. With immediate effect it is now available with three different top-part variants. These are equipped with impact sound insulation and can be ordered separately from the bottom part.

Of course, we still offer a range of service posts and workplace connection systems that deliver elegant transitions between floor and workplace.

# The new underfloor trunking system tehalit.BK Broadway

## Separate delivery of top and bottom parts

An essential change implemented for the current tehalit.BK Broadway affects the delivery form: the bottom parts as well as the top parts featuring impact sound insulation can be ordered separately now. Also new: the bottom part is delivered together with a sheet-steel assembly cover that protects the trunking's interior from soiling and damage and also prevents on-site damage prior to final assembly. Therefore Hager recommends fastening the assembly cover with the enclosed drilling screws.

The standard delivery length of the bottom is 2 m, of the top 2 x 1 m. As far as trunking width is concerned, the standard widths of 150 and 250 mm have become well-established. Standard trunking height is 85 mm, minimum screed height is still 96 mm. Customized heights and widths can also be delivered upon request. Particularly practical: with the 250 mm trunking width, two-sided device installation is possible, so that the devices can also be operated from the side of the room, which is particularly user-friendly.

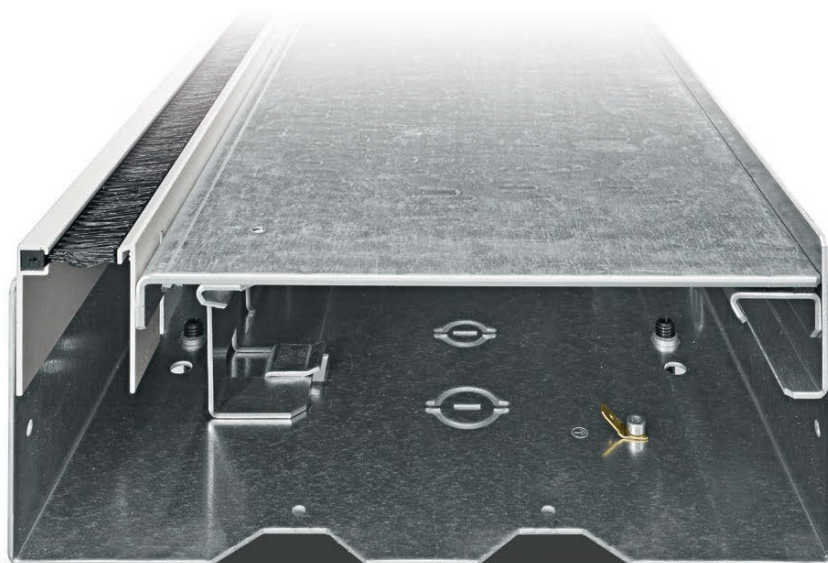

### Three delivery variants for the top-part

The electrician or end customer can choose between three top-part variants:

- open with brush
- open with brush and LED compartment
- closed

Advantage: the building owner does not have to specify the top parts during the planning phase, allowing the decision to be made when the interior design has been specified.

A change from open to closed top parts can occur anywhere. Also new: the cable outlet brush is now fastened to the bottom part. A wall-sided mounting of the brush to the bottom part has

proven to be successful under practice conditions: the cable outlet then follows the running direction of the bristles so that they stay in shape even after long periods of use. The new tehaliit.BK Broadway system also offers the following benefits: even with a wall-sided brush installation, a skirting board can be attached to cover potential gaps.

Another benefit of the new top-part design: the top part is attached to the bottom part by means of robust metal rails, ensuring a firm hold without slipping or wobbling.

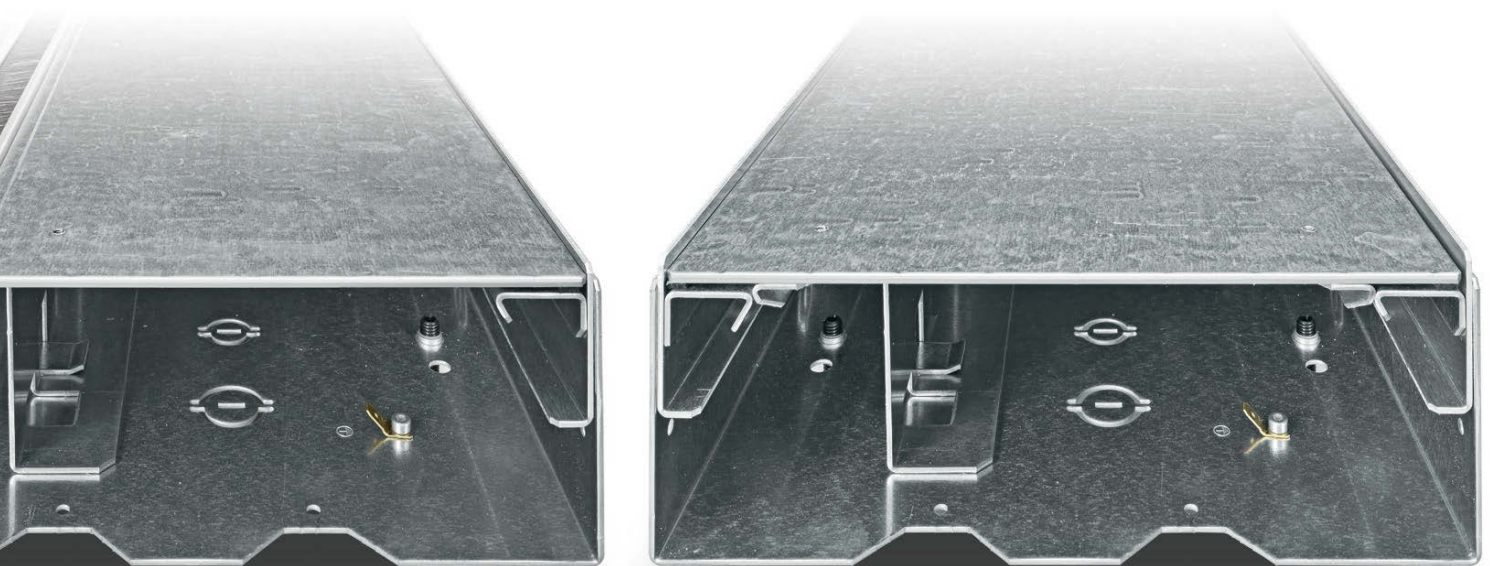

### Quick and easy: adjusting flooring height

The top part can now be very easily and precisely adapted to the height of the flooring by means of an adjustable flooring stop bar. The bottom part of Hager's new tehalit.BK roadway system now also features a preassembled aluminum flooring stop bar that can be continuously adjusted from 0 to 25 mm of height using Allen bolts, just like the top part. But the bottom part has a lot more to offer: on all three sides, it is provided with punched holes having a diameter of 20 or 25 mm. Conduits can be run through these holes – for line routing or as branch-offs to other installation systems.

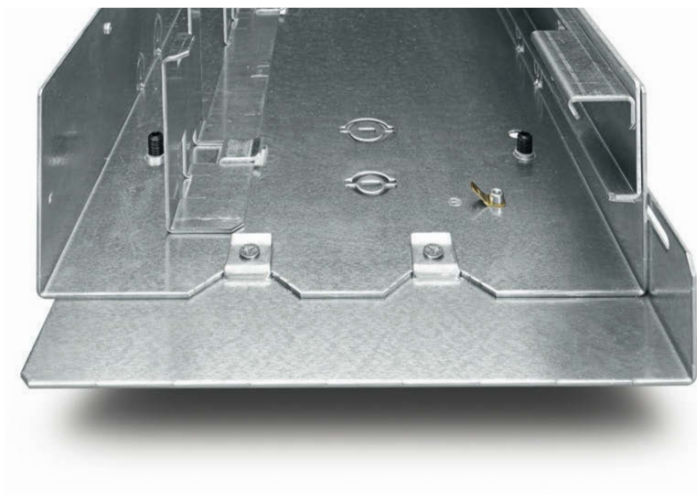
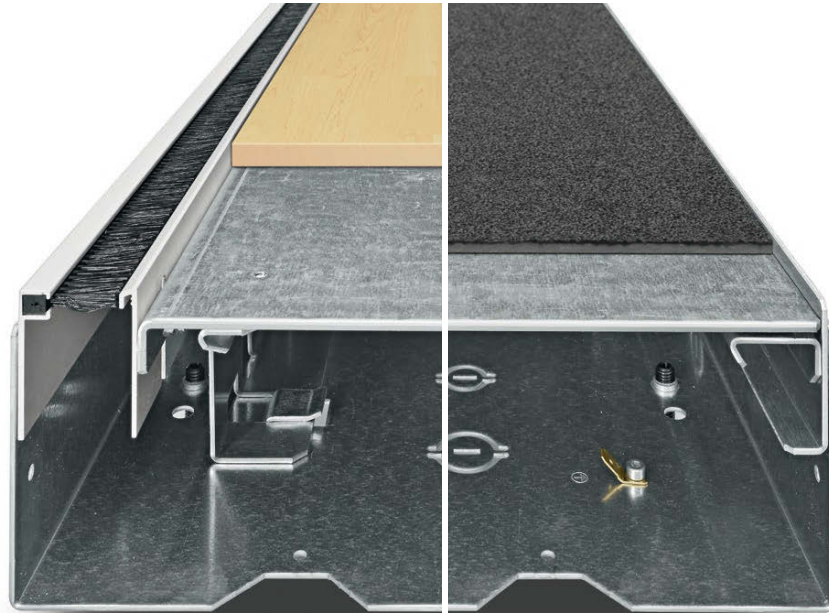

Another highlight are the bottom-part couplings – here the tabs act as a coupling sleeve and automatically center the components during assembly. Self-tapping screws that also serve as electrically conductive connectors for the bottom parts and hence as integrated earthing devices are used as fasteners. Another benefit: the design permits the removal of individual trunking elements even after assembly – for example during refurbishments.



### Shaped parts for optimal adaptability

The new tehaliit.BK Broadway system also features the proven product range of shaped parts for excellent adjustment to all building requirements. End plates with height-adjustable flooring stop bar ranging from 0 to 25 mm as well as knockout holes for inserting conduits up to 25 mm diameter are available. Self-tapping drilling screws are used as fasteners. Just like top and bottom parts, flat angles (internal and external corner) can be ordered separately. Their bottom parts are identical. They also come in the three variants "open with brush", "open with LED compartment and brush" and "closed". A T-piece rounds off the shaped-parts portfolio.



End plate



T-piece



External corner piece



Internal corner piece



# tehalit.BK roadway

## Off the wall, into the ground

Underfloor trunkings are installed in the screed and run along walls or window fronts. Unlike in-wall conduits and sockets, they offer flexibility and accessibility. Lines and sockets can be freely positioned via a folding lid. Cable outlets are located along the walls so that cables belonging to different types of media (230V, networks, TV, hi-fi) are positioned in immediate vicinity of their respective devices.

Sockets and power supply units will no longer be visible with the tehalit.BK roadway!



### A trunking that adapts to the interior design

The top part of the trunking can be covered with various types of flooring, such as parquet, carpet, natural stone or epoxy-resin flow coat and thus blends in with the remaining floor.



Parquet + laminate

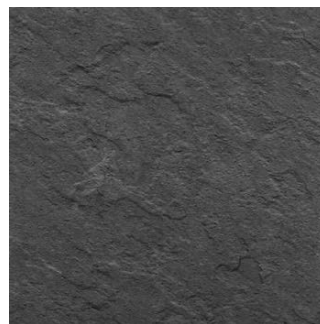

Slate



Flow coat (requires tray lid)



Carpet

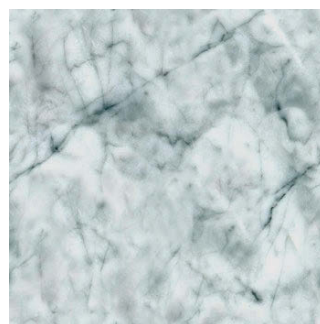

Marble



Linoleum



# Impeccable solutions just around the corner: shaped parts

In-floor trunkings must fulfill special requirements. This includes flexible adjustment to available space and utilization habits. The tehalit.BK Broadway fulfills both criteria: it can be installed almost anywhere and can be stepped on everywhere – making it flexible and robust at the same time.

## **Adapted**

Our shaped parts adapt the trunking layout to all requirements of the building structure: whether they need to be routed to the right, to the left or around a pillar – the relevant flat angles boost your cornering ability. All shaped parts are equipped with a handy cable outlet.

## **Adjusted**

In areas subject to foot traffic – such as doorways – closed trunking parts without cable outlet provide safe, clean and smooth transitions. For these areas, individual project solutions can be realized that cater to a room's characteristics and utilization habits.

## **Insulated**

The sound barrier available as accessory acts as sound deadener. This is especially important in transition areas of large offices or highly frequented conference rooms.

## **Isolated**

A firewall, also available as accessory, prevents a potential fire from spreading out. This provides additional protection.

## Assembly service

We recommend our specialized assembly teams for your projects.



### **Things coming to a good end**

The end plate made of galvanized sheet steel provides clean termination of the installation area.



### **Along the door – with closed top**

In doorways, a closed trunking top without brush ensures safe stepping without tripping hazards.

Picture on left-hand side: tehalit.BK Broadway with slate flooring and LED lighting.

# tehalit.BK Broadway

## For discrete connections

With conventional systems, all connections had to be installed in the wall – tehalit.BK Broadway now moves them into the floor. There are no holes in the wall. This is the ideal solution for areas where it is usually not possible to install connections, such as large window fronts. The flooring is attached to the trunking cover, creating a flush finish with the floor surface. The result: no visible trunkings, sockets or cables, but power lines, data lines and fiber optic cables where they are needed.

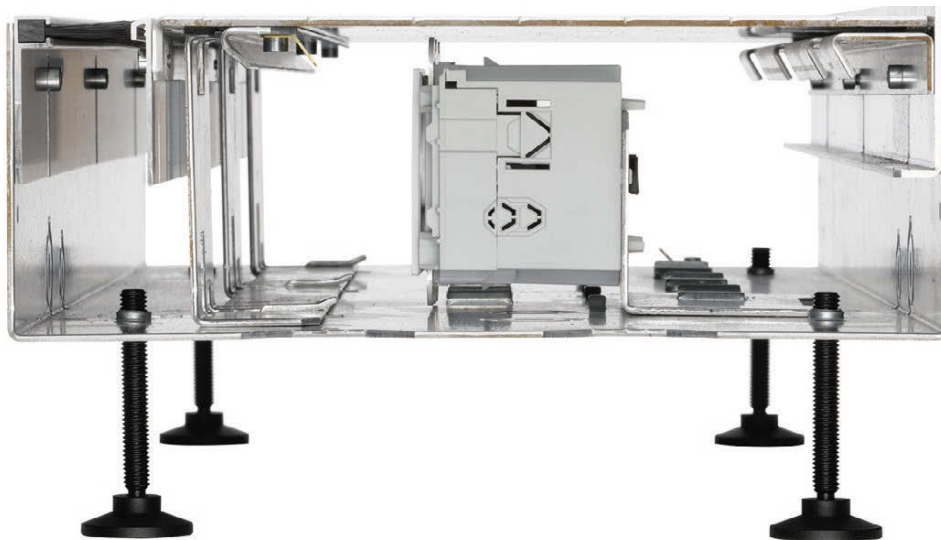

### Benefits:

- Easy and low-cost basic installation in the preliminary construction phase
- The user benefits from high upgrade flexibility
- Folding covers offer access to the installation space
- Individual installation during the final construction phase, depending on room layout and utilization
- Flexible and quick adjustments to the power and data infrastructure if utilization changes
- Perfect integration into the remaining Hager systems technology
- Storage space for excessive cable lengths

### Technical characteristics:

- Suitable for all dry-cleaned floors according to DIN VDE 0634 Part 1
- Recommended minimum height: Trunking = minimum screed height = 85 mm (including leveling screws: 93 mm)
- Height leveling via internal adjustment screws
- Uninterrupted cable outlet brush
- Length of top parts: 1 m
- Suitable for all types of floor coverings with a thickness ranging from 5 to 25 mm (flow coat requires tray lid)
- Floor covering is bonded onto the cover
- Tread load up to 150 kg/m<sup>2</sup> according to standard for raised floors
- It may be necessary to install sound insulation in the transition area between office units (sound insulation barrier, product no. L5804, see page 19)

# Expert tips

1



**Trunking made of bottom part and folding cover**  
Length of bottom part: 2 m  
Length of cover parts: 1 m

2



**LED lighting**  
The tehaliit.BK roadway trunking can additionally hold LED lighting to light up walls.

3

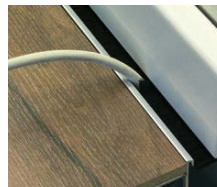

**Skirting board for trunking top parts**  
New feature for trunking top parts: a maximally 20 mm wide skirting board can now also be mounted (except for top part with LED compartment).

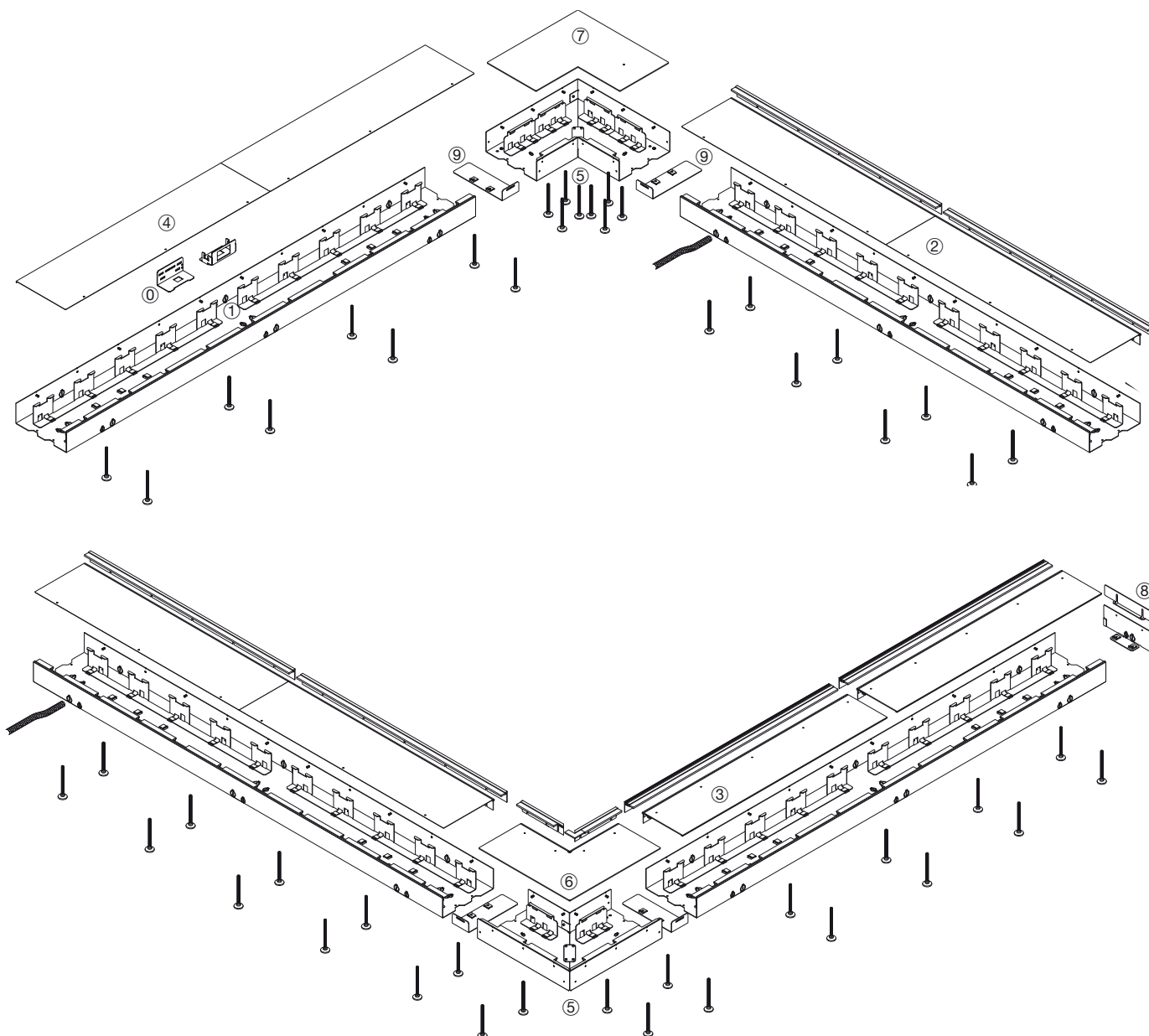

### tehalit.BK Broadway

- ① Trunking bottom part
- ② Top part with brush
- ③ Top part with brush and LED compartment
- ④ Top part closed
- ⑤ Flat angle for bottom part
- ⑥ Flat angle, outer, for top part with brush
- ⑦ Flat angle for closed top part
- ⑧ End plate
- ⑨ Coupling set
- ⑩ Device carrier for trunking sockets
- ⑪ FLF device carrier
- ⑫ Leveling screws









- Screed-flush trunking system for dry-cleaned floors according to DIN VDE 0634 Part1
- Device installation with device carriers
- Easy access thanks to removable top part and cable outlet on wall side (outlet brush)
- Minimum screed height 96 mm
- Top part can be covered with all types of floorings (parquet, carpet, natural stone, laminate, flow coat (requires tray lid), etc.) (5 – 25 mm)
- Leveling of the trunking via internally accessible set screws
- Withstands point loads of up to 150 kg
- Minimum recommendation: 4 leveling screws and 4 fastening screws per running meter (not included in the scope of delivery)
- Straightforward retrofitting capability for power and data lines
- Important: installation of edge insulation strips between trunking and screed
- Observe earthing requirements



**Available brush colors:**  
Black



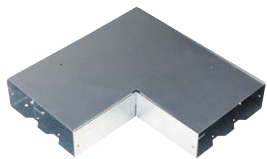
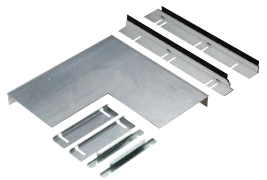
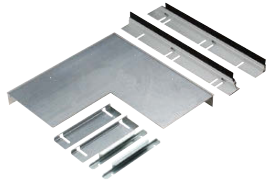

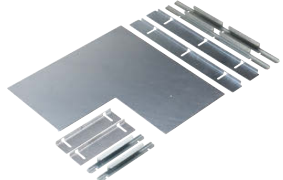

**Material:**  
Galvanized sheet steel

**Available length:**  
2000 mm  
Bottom part 2000 mm  
Top part 2 x 1000 mm

	Designation	PU	Order no.
	<b>tehalit.BK roadway trunking bottom part</b>  Dimensions of tehalit.BK roadway large (W x H): 250 x 85 mm Dimensions of tehalit.BK roadway small (W x H): 150 x 85 mm Length: 2000 mm Including assembly cover and 6 drilling screws for fastening Leveling screws not included in scope of delivery		
BKB250851	BKB25085	2	<b>BKB250851</b>
	<b>tehalit.BK roadway top part with brush</b>  Available length: 2 x 1000 mm Available brush colors: black		
BKB250852B	for BKB25085	2	<b>BKB250852B</b>
	<b>tehalit.BK roadway top part with brush and LED compartment</b>  Available length: 2 x 1000 mm Available brush colors: black Transparent area for installation of LED strip		
BKB250852BLED	for BKB25085	2	<b>BKB250852BLED</b>
	<b>tehalit.BK roadway top part closed</b>  Available length: 2 x 1000 mm For installation away from walls or doorways		
BKB250852G	for BKB25085	2	<b>BKB250852G</b>

	Designation	PU	Order no.
	<b>tehalit.BK Broadway flat angle bottom part</b>  Bottom part for flat angles, inner and outer Dimensions (W x H) 250 x 85 mm Including assembly cover and 7 drilling screws for fastening Leveling screws not included in scope of delivery		
BKB2508551	for BKB25085	1	<b>BKB2508551</b>
	<b>tehalit.BK Broadway flat angle, inner, top part with brush</b>  Available brush colors: black		
BKB2508554B	for BKB25085	1	<b>BKB2508554B</b>
	<b>tehalit.BK Broadway flat angle, inner, top part with brush and LED compartment</b>  Available brush colors: black Transparent area for LED installation		
BKB2508554BLED	for BKB25085	1	<b>BKB2508554BLED</b>
	<b>tehalit.BK Broadway flat angle, outer, top part with brush</b>  Available brush colors: black		
BKB2508553B	for BKB25085	1	<b>BKB2508553B</b>
	<b>tehalit.BK Broadway flat angle, inner, top part with brush and LED compartment</b>  Available brush colors: black Transparent area for LED installation		
BKB2508553BLED	for BKB25085	1	<b>BKB2508553BLED</b>
	<b>tehalit.BK Broadway flat angle, top part closed</b>  Top part for flat angles, inner and outer For installation away from the wall		
BKB2508554G	for BKB25085	1	<b>BKB2508554G</b>

	Designation	PU	Order no.
 BKB250858T	<p><b>tehalit.BK Broadway T-piece,</b> Galvanized sheet steel Includes 2 countersunk screws and 6 drilling screws</p> <p>for BKB25085</p>	1	<b>BKB250858T</b>
 BKB250856	<p><b>tehalit.BK Broadway end plate,</b> Galvanized sheet steel Includes 2 countersunk screws</p> <p>for BKB25085, galvanized sheet steel</p>	1	<b>BKB250856</b>
 BKB250857	<p><b>tehalit.BK Broadway coupling set,</b> Galvanized sheet steel Connector, electrical and mechanical for bottom parts Includes 4 countersunk screws</p> <p>for BKB25085, galvanized sheet steel</p>	1	<b>BKB250857</b>

	Designation	PU	Order no.
 BKBNSD60	<b>Leveling screws 60 mm height with insulation for tehalit.BK roadway</b>  8 leveling screws with insulation for height adjustment: 96 – 145 mm The indicated height range corresponds to the height of the screed.	1	<b>BKBNSD60</b>
 BKBNSD120	<b>Leveling screws 120 mm height with insulation for tehalit.BK roadway</b>  8 leveling screws with insulation for height adjustment: 145 – 210 mm The indicated height range corresponds to the height of the screed.	1	<b>BKBNSD120</b>
 L4187CHRO	<b>Earthing clamp</b>  For base terminals up to a cross section of 10 mm <sup>2</sup>	10	<b>L4187CHRO</b>
 BKBGES	<b>Device earthing set</b>  Earthing set for earthing the kallysto fastening plate In combination with device carrier BKBGTR940	1	<b>BKBGES</b>
 L4181GNGE	<b>Earthing conductor</b>  Pluggable, cross-section 4 mm <sup>2</sup> , for electrical connection of base profile and top parts as well as for bypassing shaped parts		
	L=150 mm, push-on contact	100	<b>L4181GNGE</b>
	L=300 mm, push-on contact	100	<b>L4182GNGE</b>
	L=600 mm, push-on contact	25	<b>L4183GNGE</b>
 BS90SET	<b>Fire protection foam kit</b>  For installation in walls and ceilings of fire resistance class S90 according to DIN4102 Approved by the construction authority, approval no.: Z19.15-1256. Swiss fire protection approval VKF  <b>Kit, consisting of:</b> <ul style="list-style-type: none"> <li>• 1 fire protection foam can</li> <li>• 1 filler block</li> <li>• 1 valve pliers</li> <li>• 3 spray tubes with adapter</li> <li>• 2 labels</li> <li>• 1 assembly instructions</li> </ul> Yield: approx. 2100 cm <sup>3</sup>	1	<b>BS90SET</b>
 L5804	<b>Sound barrier</b>  1 set = 15 pigtails, pigtail length: 300 mm, ø 30 mm, Attenuation approx. 40 dB, non-combustible, building materials classification A1, not suitable for use as a firewall	1	<b>L5804</b>

The tehalit.BK roadway trunking system is designed for installation along walls or window fronts for screed-flush floor installations. Installation with closed top part is also possible within a room or doorways. The trunking system comes with a top part in closed design, with brush and with an LED compartment and brush.

### Product features

- Suitable for dry-cleaned floors according to DIN VDE 0634 Part 1
- Suitable for floor coverings with a thickness ranging from 5 to 25 mm
- Floor covering is bonded onto the cover
- Recommended minimum height of trunking = minimum screed height = 96 mm
- Do not forget the edge insulation strip between trunking and screed!
- It may be necessary to install sound insulation in the transition area between office units (sound insulation barrier, product no. L5804).
- A trunking firewall (BS90SET) must be installed when routing the trunking through fire safety walls
- Other trunking heights and widths available on request
- Height leveling via internally accessible adjustment screws
- Easy access to cables and sockets is provided via the removable top part and via the cable outlet on the wall side on top parts with a brush. Length of top parts: 1 m, length of the trunking bottom part: 2 m.
- Also available as closed trunking without cable outlet for installation in areas with pedestrian traffic
- Withstands point loads of up to 150 kg
- Separate delivery of bottom part (always with fitting frame) and 3 different top parts (with brush, closed, with brush and LED compartment)

### Advantages

- Building owners can split investment requirements into separate construction and building equipment management phases
- Users benefit from great application and retrofitting flexibility with an almost invisible energy and data network infrastructure
- Simplified planning process through integration of group connection points or device installation
- Separate delivery of top and bottom parts – allowing basic installation in the preliminary building works phase and completion in the final construction phase
- Top and bottom parts are delivered separately, but the bottom part is always supplied with a fitting frame to prevent the risk of personal injury during preliminary building works
- Installation depends on room layout and utilization
- Easy options for changing the energy and data network infrastructure once the system is in use
- Removable covers offer access to the installation space
- Compatible with Hager system components
- Also suitable for use in homes for power, media and data connection systems

### Device installation

All articles from the kallysto or FLF installation device range, e.g.

- Sockets
- Network connections
- Antenna sockets

### Installation concept

#### Preliminary building works phase

1. Installation of the tehalit.BK roadway system along outer walls or glass fronts in the screed flooring. If possible, a direct connection should be made between the tehalit.BK roadway system and the distribution room or the sub-distribution.
2. Basic installation of the energy and data network infrastructure in the tehalit.BK roadway system via group connection points. The distribution and number of group connection points depends on the required volume of equipment in the office space (at least 1 group connection point for every 20 to 40 m<sup>2</sup>).
3. Installation that is compliant with the following standards by using group connection points or conventional connections:
  - Energy distribution systems: DIN VDE 0634 Part 1 and Part 2, DIN VDE 0100 (in particular Part 520), DIN VDE 0105,
  - Data network systems: Structured wiring in accordance with EN 50173-1, EN 50173-4, EN 50174-2

#### Final construction phase

1. Individual installation only once room layout and utilization have been defined
2. Connection of consumers close to walls directly via group connection points (no additional installation components required)
3. Connection of consumers out in the open using additional Hager system components
4. Pluggable connection systems for safe and reliable installations

#### Usage phase

5. Flexible and quick changes can be made to the power and data cabling whenever room layout or utilization type change.
6. Optional installation of skirting boards

#### LED lighting

1. The Hager company does not sell LED lighting.
2. Commercially available LED strips fit into the LED compartment of the tehalit.BK roadway top part.

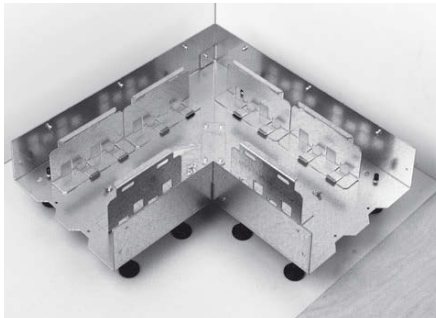

1. Screw in leveling screws.
2. Align trunking bottom part or internal/external corner piece on wall side.

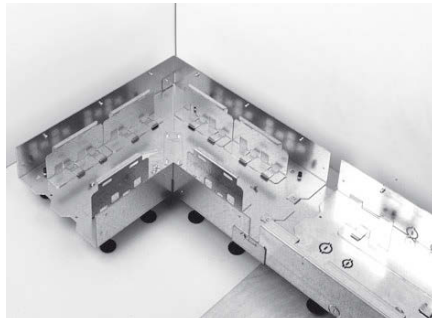

3. Joints are connected via couplings. The ends of the trunking are sealed off with end pieces. No screed must be allowed to penetrate inside the trunking. Using the screws enclosed, a conductive connection is established between the coupling and the bottom parts.

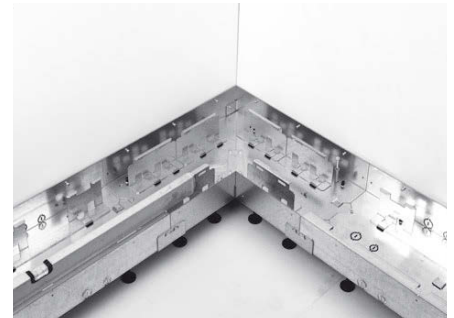

4. Leveling of the trunking. The trunking itself forms the setting edge for the screed, so the leveling process must be coordinated with the company laying the screed. Minimum recommendation: 4 leveling screws per running meter.
5. To prevent a possible thermal bridge between trunking and slab, the hollow space underneath the trunking shall be lined with insulating material.



6. Secure trunkings on slab using fastening screws. Minimum recommendation: 2 fastening screws per running meter.
7. Put the fitting frame in position.



8. If necessary, connect conduits; open cut-outs beforehand using a flat-tip screwdriver. Conduits can be connected on four sides.



9. Screw in the fitting frame using the drilling screws enclosed with the trunking (in the attached film pack). These are screwed directly through the bores in the fitting frame into the support of the bottom trunking part (without pre-drilling).

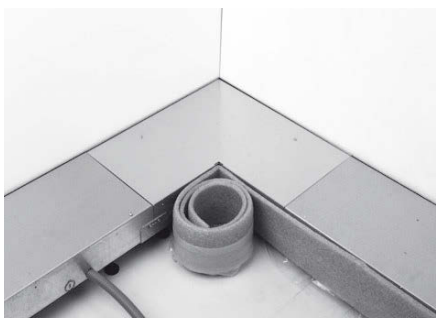

10. Attach the wall insulation strip on the side of the trunking facing the screed (make sure that no screed runs under the trunking). Special precautions must be taken when using floating screed, hot screed or aggressive screed. Depending on the floor covering (e. g. liquid material), it may be necessary to consult the manufacturer. If an insulation strip is also required on the side of the trunking facing the wall, it shall be attached prior to assembly point no. 4.



11. If necessary, support the side of the trunking facing the screed to prevent the side wall from bending under the pressure of the screed. The screed layer needs to work the screed cleanly and carefully up to the level of the top edge of the trunking. Make sure that no screed or parts of the floor covering (e. g. liquid material) can run into the trunking.

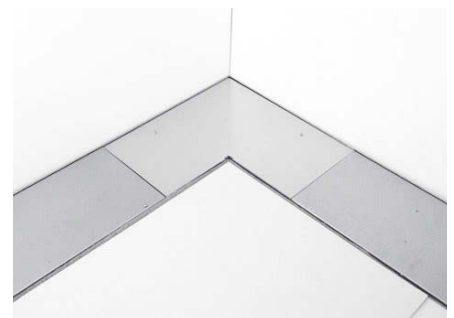

12. Screed installation

13. All metallic parts of the trunking system must be covered by VDE-compliant protection measures.
14. Installation of the floor covering (0 – 25 mm).
15. Floor covering adjustment variant 1 – with brush:  
The outlet brush supplied with the top part is attached to the wall side of the trunking bottom part. It is pushed up or down to the corresponding height of the floor covering in the same way as the flooring stop bar that is attached to the trunking bottom part. Once adjusted, it is secured in place using a 3-mm Allen key (not included in the scope of delivery).
16. Floor covering adjustment variant 2 – closed:  
The flooring stop bar supplied with the top part and the support for the top part are attached to the wall side of the trunking bottom part. It is pushed up or down to the corresponding height of the floor covering in the same way as the flooring stop bar that is attached to the trunking bottom part. Once adjusted, they are then secured in place using a 3-mm Allen key (not included in the scope of delivery). Note: the „support rake“ (system carrier) in the bottom part must be moved to allow the top part to fit.
17. Floor covering adjustment variant 3 – with LED:  
The outlet brush supplied with the top part is attached to the wall side of the trunking bottom part. It is pushed up or down to the corresponding height of the floor covering in the same way as the flooring stop bar that is attached to the trunking bottom part. Once adjusted, it is secured in place using a 3-mm Allen key (not included in the scope of delivery). Note: the „support rake“ (system carrier) in the bottom part needs to be moved to allow the top part to fit.

**We recommend having the tehalit.BK roadway system installed by our assembly team.**

## tehalit.BK roadway Cross-sectional view of the underfloor trunking

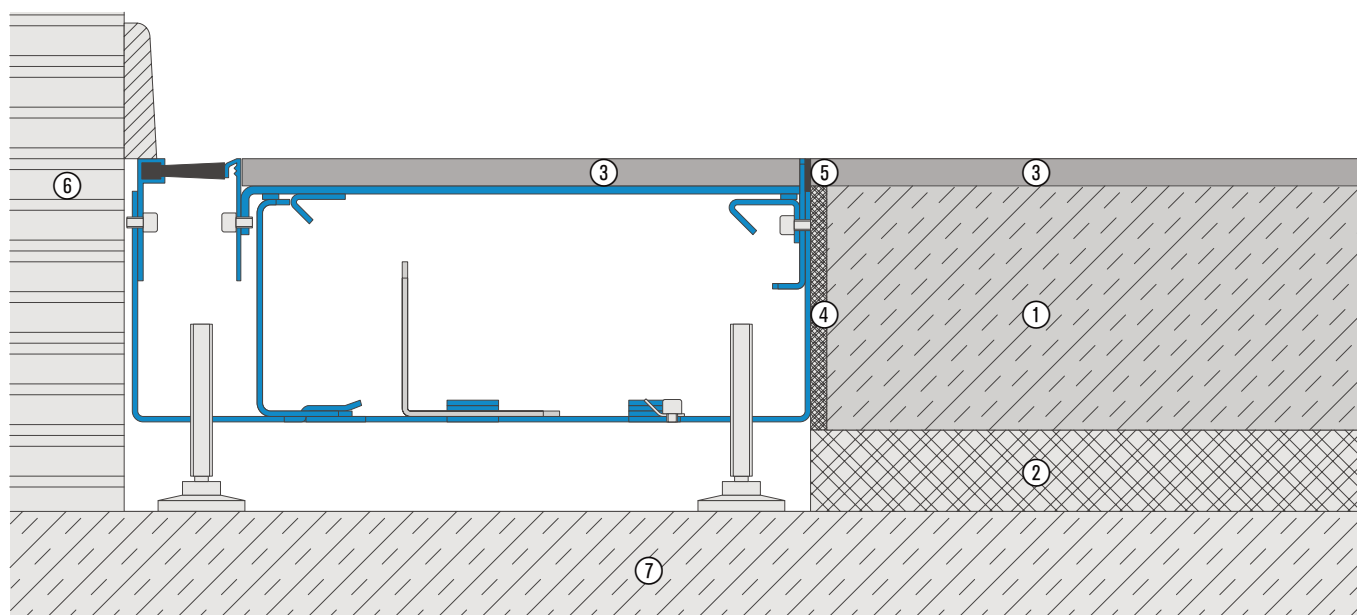

1. Screed
2. Impact sound insulation and thermal insulation
3. Flooring
4. Insulation strip
5. Connection joint
6. Wall
7. Slab

Hager Vertriebsgesellschaft mbH & Co. KG  
Zum Gunterstal  
66440 Blieskastel  
Germany  
Phone: +49 (0)6842 945 0

Hager Electro S.A.S.  
132 Boulevard d'Europe  
B.P. 3  
67215 Obernai cedex  
France  
Phone: +33 (0)3 88 49 50 50  
Fax: +33 (0)3 88 49 51 44  
[www.hager.com](http://www.hager.com)

