

tehalit ceiling installation system
Wiring spacious rooms flexibly.

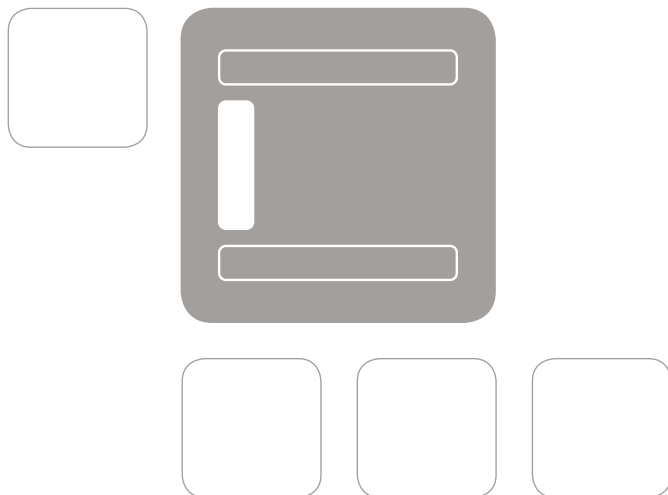

Well prepared
with Hager
wall-installation
systems



Ahead of their time:
with Hager
ceiling-installation
systems

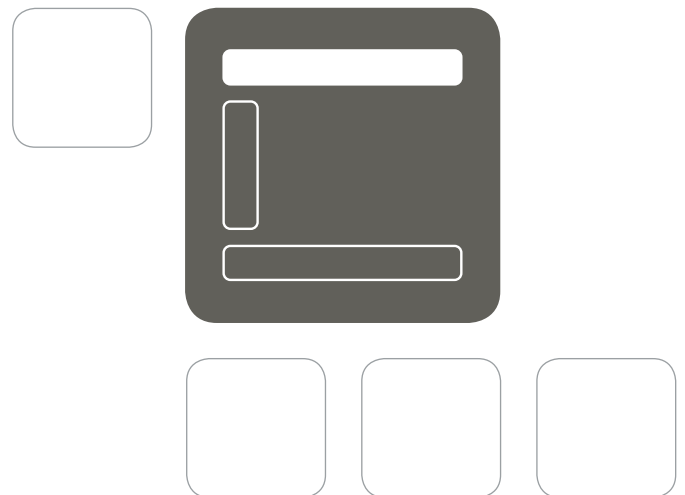

Walls, ceilings, floors: Hager's all-round package

Electrical installations require a three-dimensional approach: optimal solutions that fulfill both technical and visual requirements can only be found once you look and think in all directions.

This has always been one of our strongest assets. As specialists for electrical installations in residential and commercial buildings, we tend to look up and down, left and right – but mainly ahead. Our conclusion: the ideal solution is a question of perspective. We have therefore developed

installation solutions for floors, walls and ceilings and dedicated separate brochures to these fields. They will give you room for ideas – open up!

Well positioned
with Hager
floor-installation
systems

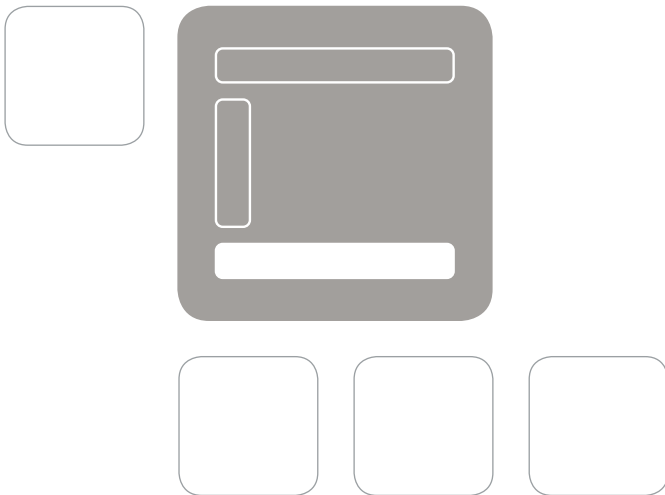

Contents

Introduction	4
Ceiling-fed cable tray tehalit.DAB	6
Ceiling-fed service pillar tehalit.DA	16
Floor-fed service pillar tehalit.DAP	24
Ceiling-fed service pillar "exklusiv" tehalit.DE	28
Floor-fed service pillar "exklusiv" tehalit.DEP	31



All advantages at a glance

- Modern electrical infrastructure for old and new buildings
- Optimal wiring of the utilized area
- Cost-optimized basic installation
- Attractive interior design feature
- Highest degree of flexibility in expanding or changing existing systems
- Planning and assembly made easy

www.hager.com



Good corporate management starts with good line management.

Working in lofts is becoming ever more popular as more and more advertising agencies, architects offices and law firms are moving there. The combination of historically grown settings and modern office architecture does not only have a special appeal to it. It also poses high challenges on electrical installations. Our room installation system hooks you up to the modern age.



The challenge

Today's open-plan offices require every workplace to be supplied by a large number of power, data and communication lines. In addition, employees today demand ergonomically sound workplaces. Especially older buildings, though, are not prepared for this kind of modern electrical infrastructure. Most of the time, lofts are several meters high, so that routing lines via the ceiling is out of the question, especially in the case of pure wood or steel structures. In listed buildings, it is often not permitted to route lines through walls, as this represents an intervention into the building structure. Another obstacle is that workplaces not located immediately near walls are difficult to connect. This applies to old and new buildings alike.

The solution

Our room installation system offers a quick, simple and cost-efficient solution. It routes power and data lines flexibly to where they are needed – both horizontally and vertically. The result is quite remarkable, as you can see in the picture above.

We are convinced: your customers will also be pleased!

tehalit.DAB

No need to suspend your ceilings.
Keep your competitors in suspense instead.

The tehalit.DAB ceiling-fed cable tray gives you quite a competitive edge over any conventional electrical installation. It is not only quicker and more cost-effective to install, it can also be easily adjusted to new requirements without substantial building efforts. And the result looks good, too!

Two profiles, two sizes, many benefits

The cable tray consists of two parallel aluminum or sheet-steel profiles which are mounted to the ceiling by means of ceiling brackets. Suspending ceilings is therefore no longer necessary. The ceiling structure remains fully intact. Potential obstacles are cleverly "bypassed". Floors and walls are not affected and can be utilized otherwise, e. g. for shelves, artwork or window fronts.

More safety on the ground

Safety and ergonomics are also improved, as there is no longer any risk of tripping over cables or floor-mounted trunking systems. As a side effect, this also facilitates and accelerates cleaning work – a non-negligible cost factor!

So: show your customers the way to go –
along ceilings with the new cable tray.

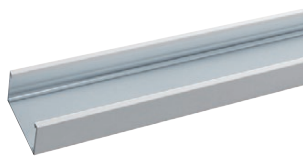

Slim fit: the 80 mm aluminum profile

The slim design of the aluminum cable tray has a high-quality appeal to it and blends unobtrusively into the room. The aluminum profile is available in pure white, aluminum white or naturally-anodized aluminum*, adding an exquisite modern touch to your installations.



Broad and strong: the 160 mm sheet-steel profile

The wide sheet-steel version is used wherever high-volume power and data infrastructures are needed. It also offers sufficient space for consolidation points. The 160 mm profile is available in pure white or aluminum white*.

* Accentuating special colors are available upon request. There are no limits to your customers' creativity.

Make way for large power and data volumes.

From below, it looks like an elegant design feature, from above, it turns out to be a perfectly organized electrical distribution system. Power and data lines go their separate ways: they are routed in two separate trunkings, providing a well-structured layout and an optimal separation of functional areas.

Cable routing instead of cable clutter

Excess line lengths can easily be stowed away in the cable tray, resulting in a harmonious overall appearance. With the 160 mm sheet-steel profile, standardized consolidation points can be set up as decentralized connection interfaces.

Always "on top" with assembly and maintenance

As the profiles of the cable tray have open tops, installation, repair and extension work can be done comfortably from the top. The complicated process of opening suspended ceilings and tiring overhead "cable fumbling" are a thing of the past.

Setting the course correctly:

The updated DIN EN 50173-1 standard gives you more freedom with electrical installations. With the cable tray, you can make optimal use of it e. g. by setting up consolidation points for the energy and data lines. You can benefit from more flexibility in your installation work and an uncluttered infrastructure.

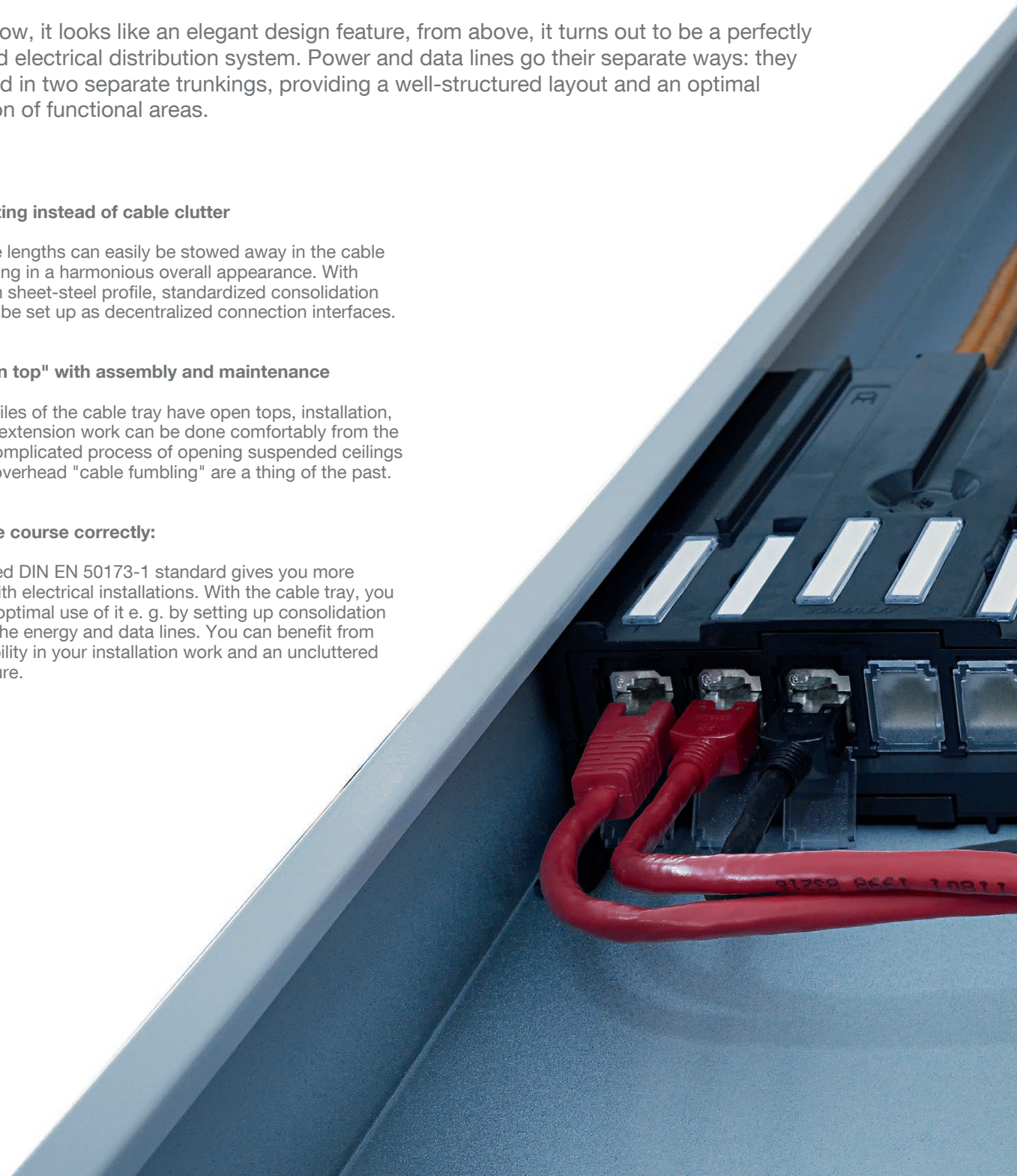

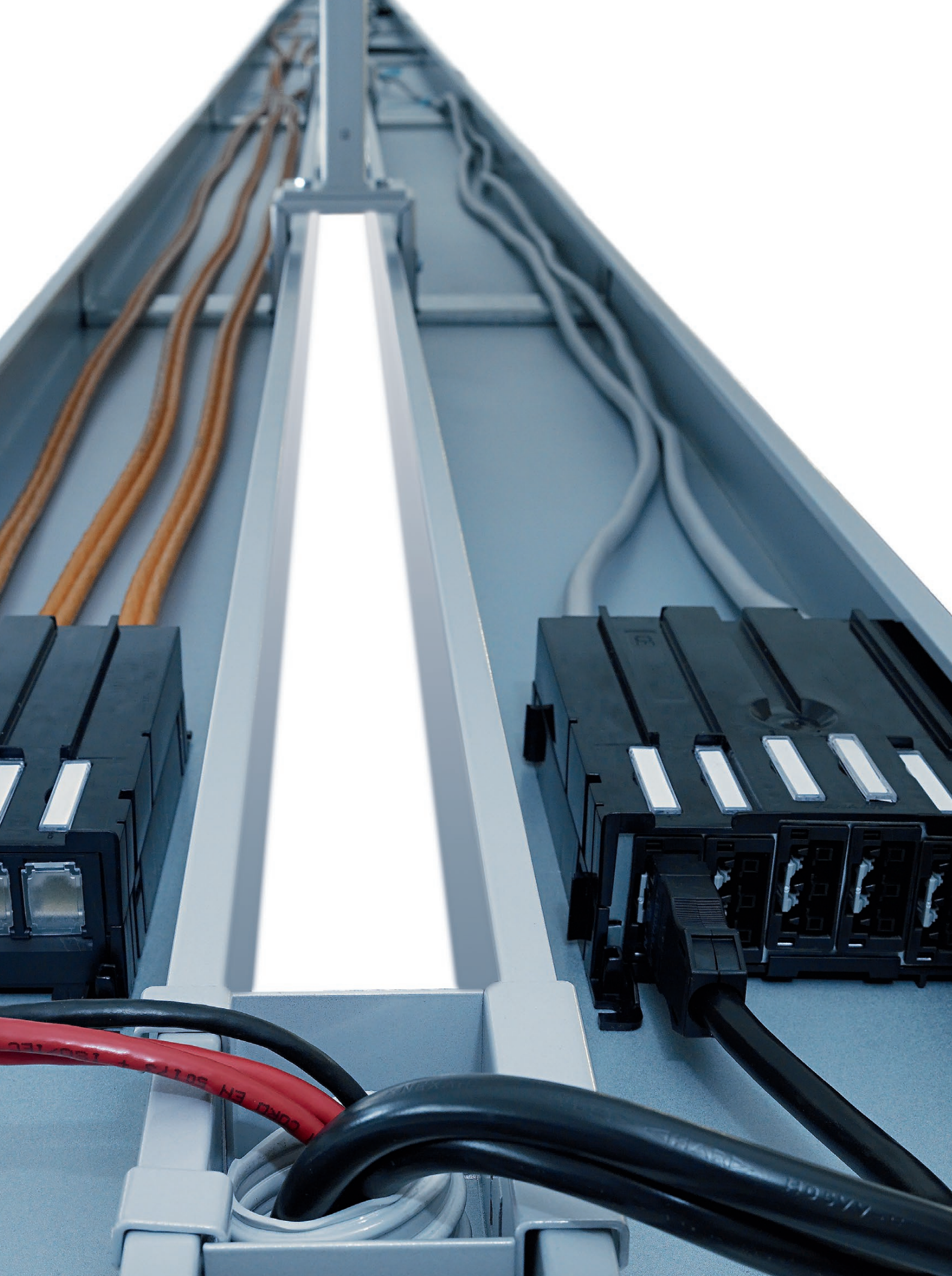



Everything looks even better in the right light!

Good light is essential when it comes to creating a pleasant living and working environment. This is even more important in open-plan offices where people tend to work long hours. The tehaliit.DAB cable tray is ideal for technically and esthetically demanding lighting solutions.

Light on demand

Whether your objective is to achieve a soft overall illumination or an accentuated illumination, the DAB system helps you to implement these lighting concepts flexibly. The required power is available across the entire surface, whether you are dealing with wall or ceiling installations, so you can tap it wherever it is needed – without having to climb to the ceiling when mounting lamps.

Customized installation

Matching adapters for the illumination are available as accessories and are perfectly aligned to the cable-tray design. Should the light requirements or room utilization change, more lamps can be added, the existing lamps can be reduced or relocated any time – simply by moving the adapter.

Your customers have even more individual illumination requests? We are happy to develop customized solutions for you that match your design. All you need to do is contact us!



Spotlight on

The interim space of the cable tray can be perfectly fitted with high-quality lighting solutions, such as ceiling lights from Spectral, spot-lighting specific features. We also supply adapter parts to match.



Soft light for bright people

Panel lights are ideal for illuminating rooms with a soft, shadow-free light. With its naturally-anodized aluminum frame, the lamp by Regiolux perfectly matches our cable-tray design and immerses the room in a pleasant and uniform light.



Please note:

Apart from lamps, you can also attach information signs, e. g. restroom or emergency-exit signs to the cable trays. Simply use the universal adapter which is available as accessory. Just as easily, loudspeakers or smoke detectors can be mounted to the cable tray.



A convenient peg

Lamps and other applications can be safely fastened with the universal adapter made of robust sheet steel that can easily be moved if necessary.



Rounding every corner at the ceiling: flexible shaped parts.

Our cable trays are not only leading the way technology-wise, they also find their way everywhere. Our practical, perfectly designed shaped parts reach every corner of your room conveniently.

Our shaped parts – your benefits

The shaped parts are flexible in two regards. Not only do they permit spontaneous changes in direction to every corner of the room. They are also designed to level out inaccurately aligned cable trays imperceptibly. This gives you "more play" during installation without diminishing the final result.

All shaped parts are made of robust sheet steel and are available in the colors pure white and aluminum white.

Customized: tailor-made solutions on customer request

If requested by the customer, we love to develop individual solutions – such as this beautiful installation that we created in cooperation with the Osram company, providing a relaxed atmosphere for every meeting.

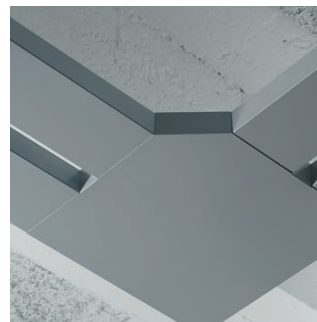
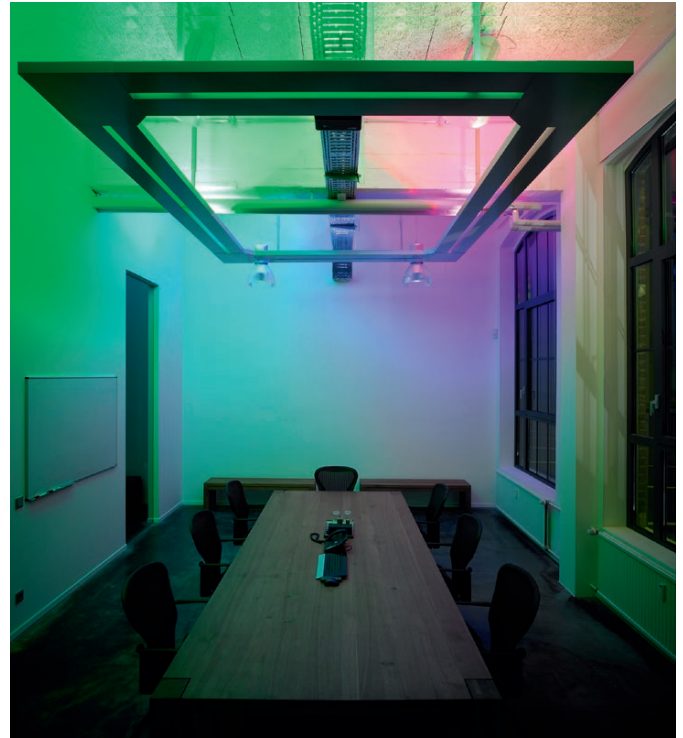

Flat corner

Attractive shape, flexible function: The flat corners with their characteristic beveled edge can be used as internal and external corners and conceal assembly tolerances over longer profile distances.

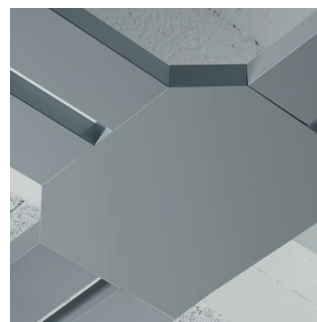

T-piece

Using the sheet-steel T-pieces, power and data lines can be branched off at a right angle, providing for even more flexibility in line routing.



End plates

End plates ensure esthetically clean edges. For profiles ending on walls, practical wall end plates can be used (see accessories)

Overhead assembly made easy.

We pursue only one objective in all our developments: making your life as easy as possible when it comes to planning, assembling and performing electrical installations. You will most certainly notice the competitive edge the tehalit.DAB cable tray holds over conventional wall or ceiling installations. Benefiting you and your customers!

No chisel, no dirt

You do not need to chisel slots or suspend or break through ceilings to mount the cable trays. Hammer and chisel are a thing of the past. Everything you need is a drill, a wrench and a pair of skilled hands.

Quick in, clean out

The assembly steps were reduced to a minimum and simplified as much as possible. Your customers will benefit as well: when you finish off earlier and do not raise as much dust with your work, your customers can use their rooms again sooner and even save on cleaning costs.

A true win-win situation!



Here is how it works:

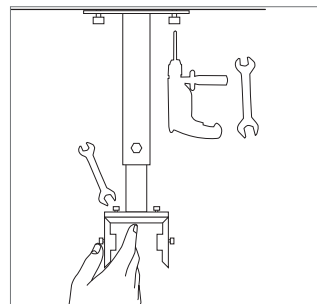

Mounting the ceiling brackets
Mount the cross beams to the ceiling brackets first. This should be done while the bracket is still on the floor. Then mount the brackets to the ceiling at the specified intervals, level them out and lock them with a hexagon bolt. The final securing of the ceiling brackets requires an additional bolt. The hardest part is over!

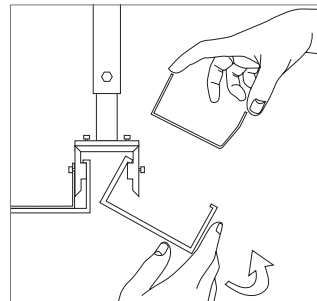

Inserting the profiles
Now we continue without tools: The profiles are inserted manually and stay in position. That takes the strain off your arms!

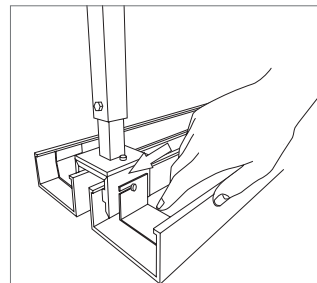

Aligning the profiles
Latching sheet-steel brackets are used to lock the profiles in horizontal position. This step does not require any tools either.

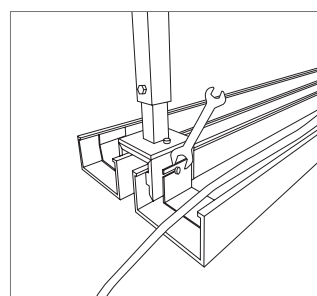

Locking and filling the profiles
Use the wrench for final locking of the profiles. Now you can route the lines. Please observe the permissible cable load!

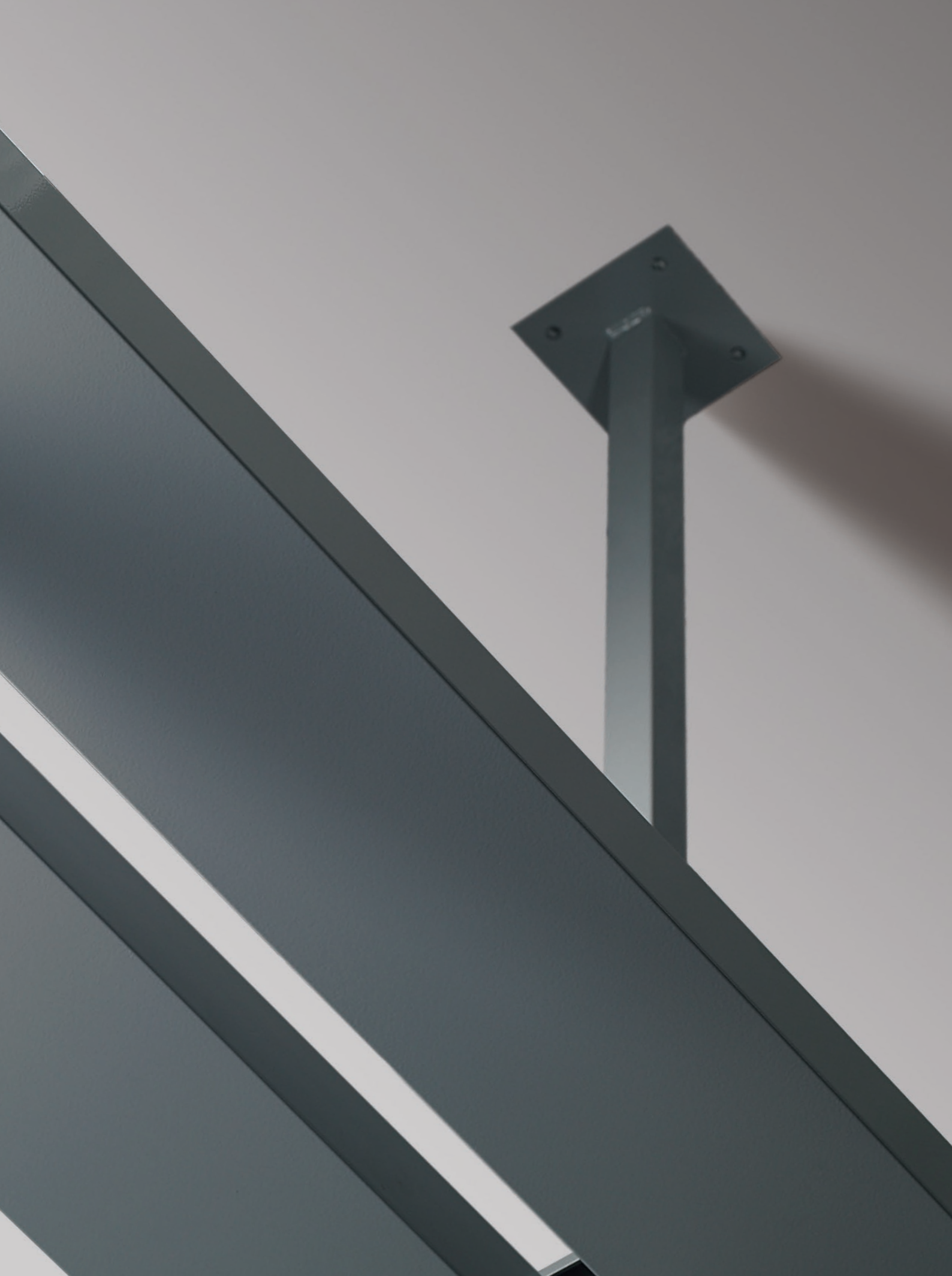

tehalit.DA

Reaching every corner from the ceiling. Thanks to the tehalit.DA ceiling-fed service pillar

Power supply from the ceiling has been made available. Now the individual workplaces need to be supplied with power and data. This is where the tehalit.DA ceiling-fed service pillar comes into play. It perfectly matches the cable tray as far as technology and design are concerned and creates a smooth transition from the horizontal level to the vertical level.

Three variants for all types of requirements

The ceiling-fed service pillar is available in three versions to cater to different room heights and different purposes: using the clamping system, mounting-bracket system or flex system (see next pages). Power is supplied either from the ceiling – e. g. via the cable tray – or from the floor. All ceiling-fed service pillars are available as single or double variants, depending on the number of workplaces that need to be supplied. Set-up and device installation can be performed by a single person without the need of assistance. Should utilization habits change, the pillars can be moved flexibly and without longer downtimes.

Well-structured technology for maximum safety

tehalit ceiling-fed service pillars do not only ensure smooth power and data traffic. They also improve staff "traffic". Tripping hazards are eliminated as trailing cords are no longer an issue. This reduces the risk of accident and damage to a minimum.

Clear design for highest demands

Thanks to their straightforward and clear design, the ceiling-fed service pillars smoothly blend into every modern office landscape. Their timeless elegance and high material and manufacturing quality ensure a long utilization period. All ceiling-fed service pillars are made of aluminum and are available in naturally-anodized and in pure white color. Special colors and individual surface coatings are available upon request.



Lever action assembly: clamping pillars in position.

Installing pillars over the full height between floor and ceiling requires a secure attachment on both ends. This is precisely what the tehaliit.DA ceiling-fed service pillar with integrated clamping system stands for. It rests on a solid, non-slip base and is fixed against the ceiling by a clamping plate.

Stability is ensured by the powerful clamping mechanism with its Fastfix function, which is activated by turning a lever – no tools needed! The integrated spirit level ensures perfect vertical adjustment. Relocating the pillar is just as easy as setting it up, should lines and ports be required at a different location within the room.

The ceiling-fed service pillar with clamping system is available in four sizes to fit rooms between 2.50 and 3.70 meters high.

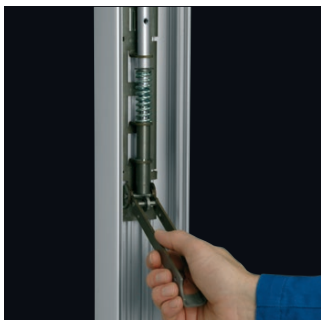

Assembly at eye level

The clamping system can be moved up and down for your convenience when performing assembly work.



Perfect alignment

The integrated spirit level facilitates perfect vertical adjustment. It is height-adjustable as well so that you can always keep an eye on it during assembly.



Lever-action simplicity!

Once the pillar is adjusted, all you need to do is turn the lever to lock the pillar against the ceiling. Nothing could be easier!



Firmly based

The robust base is made of die-cast aluminum. Its non-slip profile ensures maximum stability despite its small footprint.



Clean end

The elegantly shaped ceiling concealer facilitates assembly and enhances the visual appeal.



Quickly assembled – neatly covered

Obtaining maximum performance from minimal space requires a smart approach. This is why all ceiling-fed pillars feature the front-latching device installation system that has proved its worth millions of times.

The system allows power sockets, data and communication or antenna ports to be installed in stacked arrangement. Power sockets connected to the same circuit can even be mounted sequentially. All lines are clearly arranged and routed and do not need to be threaded in separately.

Matching modular covers with and without identification label conceal gap lines while creating a smooth and uniform surface design.



No limits ...

The spacious wiring compartment allows you to sequentially fit any number of power sockets required, matching covers included.



... for any connection type

From the small RJ45 data port to the large CEE rotary current socket – the ceiling-fed service pillars allow you to realize any type of connection.



Keep on moving: the flex system

The tehalit.DA ceiling-fed service pillars with flex system combine stability with flexibility.

Their cast-iron base weighs 15 kg to ensure maximum stability, yet allowing the pillar to be moved about in the room. The pillars can be moved within a radius of up to 1.5 meters around their connecting point at the ceiling, depending on ceiling height. Power and data lines are fed into the pillar from above via a hose, either from the ceiling or from the cable tray.

Ceiling-fed service pillars with flex system are only available in lengths of 2 meters.



A sound base
The vibration-absorbing base made of solid cast-iron ensures a safe footing on any surface. Footprints: 300 x 300 mm (for single variant) and 300 x 340 mm (for double variant).



Flexible connection
The practical hose bundles all lines, routing them to the ceiling or cable tray as one uniform element. Matching adapters provide the right connection.



Secure attachment
A clamping connection reliably secures the hose to the pillar.

... thanks to the mounting-bracket system.

If the ceiling is not suitable for clamping the pillar into place, then the mounting-bracket system may be an alternative.

Here, the pillar is secured to the intermediate ceiling's substructure by means of a variable bracket made of galvanized sheet steel. This provides inherent stability to the room installation system. An integrated spirit level ensures the correct vertical adjustment of the pillar. The system can be installed by a single person.

Ceiling-fed service pillars with mounting-bracket system are available in two standard lengths of 2.80 and 3.40 meters. Custom lengths are available upon request.



Ready, steady - done!

The bracket is fastened to the existing substructure. It is available as a single or double variant, depending on the pillar width.



Shedding lights on your customers. Individual lighting solutions.

Good light is a prerequisite for focused work. With this in mind, we have prepared the tehalit.DA ceiling-fed service pillars – like the tehalit.DAB cable tray – for state-of-the-art office lighting systems.

The high-quality, non-glare panel lights from Waldmann (see above) are just one example of how to create a pleasant work ambience.

Thanks to their anodized aluminum frames, these lights integrate perfectly with the pillar design. And they even look good during daytime when the lights are off.

Lights from other manufacturers can also be integrated into the ceiling-fed service pillars without a problem. Please contact us if you have any questions!



A true highlight

Non-glare panel lights from Waldmann can be manually adjusted to your personal requirements to create a pleasing lighting ambience.



Artwork meeting the art of lighting

Whether you prefer e.g. a horizontal double-panel light from Waldmann (right) or an integrated RGB light strip with changing colors as realized in cooperation with Osram (left) – we will be happy to tailor lighting solutions to your individual requirements and personal taste. Put your electrical installation into the right light.



tehalit.DAP

Firmly rooted routing. The tehalit.DAP floor-fed service pillar

Some projects demand the electrical installations to be integrated into the ceiling. Other objects require the lines to be routed to their point of use through the floor.

Either way – Hager can offer the ideal space-saving solution: the floor-fed service pillar in high-quality aluminum design. It allows you to realize electrical installation anywhere in the room – quickly, flexibly and in style.

The floor-fed service pillar represents the state of the art. And it keeps up with those working with it every day. It provides all power and data sockets at a convenient height from a seated position. No more cable clutter on the floor, no more bending down to plug or unplug cables! This means enhanced ergonomics and less pain in the back.





Plenty of connections in compact space: by flexible device installation.

The tehalit.DAP floor-fed service pillar is at a par with its ceiling-fed counterpart. It is just a little bit shorter, but without compromising functionality, of course.

The floor-fed service pillar is available as single and double variant. It features the front-latching device installation system for all socket types found with the other trunking variants. Retrofitting is possible at any time. Modular covers with a slightly convex profile create an appealing surface that also covers the trim lines.



Perfect table service

Always at hand when needed. No more bending down, pushing chairs – and no more strain on the back!

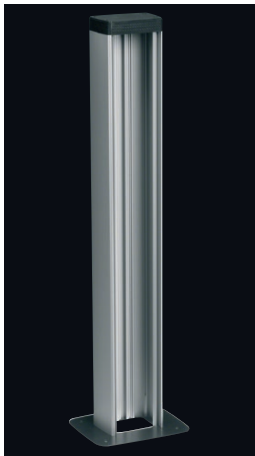

The simple solution ...
The floor-fed service pillar in its single variant.

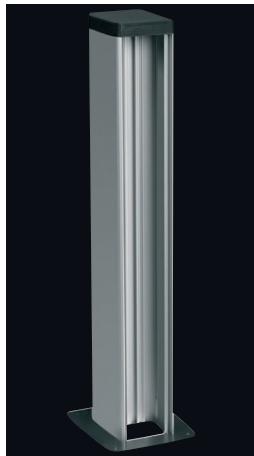

... simply doubled up
The floor-fed service pillar in its double variant serving several work places.

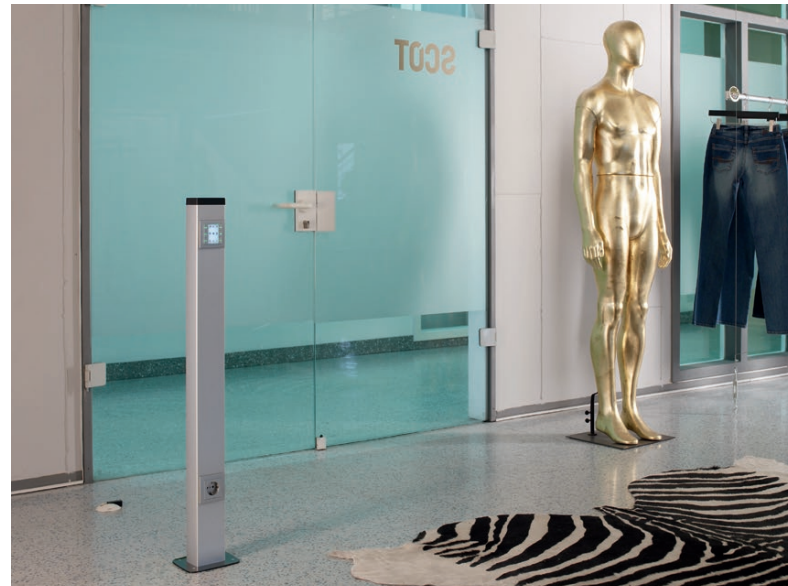

Attractive project solutions

Floor-fed service pillar in custom length with integrated power connection and KNX button for building automation control from the kallysto® switch portfolio. Your customers have special requests? Let us assist you in meeting your customers' expectations.

tehalit.DE

For all those with higher aspirations. The tehalit.DE "exklusiv" ceiling-fed service pillar

As you have seen, our standard ceiling-fed and floor-fed service pillars are already in good shape. However, some customers demand something special beyond the ordinary! Such a demand may come from a renowned architect's studio, a high-ranking law firm or an established doctor's practice. In such environments, the visual appeal must make a statement beyond mere technical functionality.

Our design pillars meet both targets: To combine ultimate technical functionality with exclusive styling. Their black anodized aluminum surface makes these pillars true eye catchers in any room. The convex surface adds a delicate, elegant touch.

Our design pillars are a unique blend of form and function, allowing you to extend your business to a range of promising customers!





**High ceiling, secure attachment:
the tehalit.DE ceiling-fed service
pillar with clamping system**

Ceiling-fed service pillars with clamping system are very versatile. They are available in three sizes to fit rooms between 2.70 and 3.60 meters high.

Thanks to the handy clamping system, they can be fixed to any solid ceiling by simply turning a lever. Operating the lever adjusts the height by up to 30 centimeters.

A spirit level is integrated for perfect vertical adjustment. Assembly requires a single person only, no tools needed!



**Reliable stability, maximum
flexibility: the tehalit.DE ceiling-
fed service pillar with flex
system**

The ceiling-fed service pillar with flex system offers additional flexibility. Its profile is 2 meters long, and it can be moved within a radius of up to 1.5 meters from its connection point, depending on ceiling height. Cables are concealed by the sleek black fabric hose that creates an elegant connection to the ceiling connection point.

The precisely machined round base ensures stability (base to be ordered separately). For assembly, the pillar is placed on the base and is then secured with one stroke of a hammer onto the locking key.

Particularly practical: thanks to its clever design with spacious cavities, the pillar can be set up almost anywhere – it will even fit the leg of a table, should the discriminating viewer find this acceptable.

tehalit.DEP

The ceiling-fed and floor-fed service pillars of the "exklusiv" line in overview.

Small and discrete: the tehalit.DEP "exklusiv" floor-fed service pillar

The tehalit.DEP "exklusiv" floor-fed service pillar is the system of choice wherever lines are routed in the floor while the expectations in terms of design and styling are on a high level.

It offers almost the same features as the classic tehalit.DAP floor-fed service pillar, but its styling rather resembles that of its larger "colleague" to the left. The floor-fed service pillar not only makes work easier, but also creates a nicer ambience. After all, a business environment is also a matter of style!



High-level demands, optimal connections:

All "exklusiv" ceiling-fed service pillars with clamping or flex system and all "exklusiv" floor-fed service pillars are assembled with devices at the factory and are supplied ready to be connected. A completely wired graphite-black device module comprising five power sockets and four Cat.6 ports comes as standard.

If these connections are not enough, an additional module with five power sockets and four data ports can be installed on the rear side of the profile. Ceiling-fed service pillars of the "exklusiv" range come with 6.5 meter long lines, their floor-fed variants are supplied with 3.5 meter long lines. From these lengths, a minimum of three meters from the end of the profile is available for making the connections.

It is obvious: The ceiling-fed and floor-fed service pillars of the "exklusiv" range provide anything that even the most demanding customers need to stay connected!



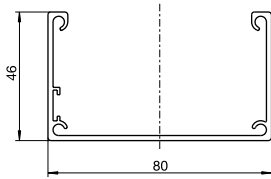

Loading of the usable cross section

- Maximum cable load of DABA500801:
- max. 16 kg/m for a support distance of 1.5 m
- max. 10 kg/m for a support distance of 2.5 m
- Load test was performed based on standard EN 61537 "Cable management. Cable tray systems and cable ladder systems".
- Usable surface of DABA50081: 42 cm² (2 x 21 cm²)

- max. number of cables

- 3 x 1.5 mm²: 58
- 5 x 2.5 mm²: 34
- Cat.6 cables: 66

- Observe maximum cable load
- Observe earthing requirements

Available length

3000 mm

Notes on delivery:

2 m profile need to be ordered per 1 m cable tray

Available colors for DABA

- RAL 9010, pure white
- RAL 9006, aluminum white
- ELN, naturally-anodized aluminum

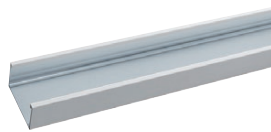

DABA cable tray, aluminum

Designation	PU	Order no.
Cable tray 50x80, alum., naturally-anodized	24	DABA500801ELN
Cable tray 50x80, alum., aluminum white	24	DABA5008019006
Cable tray 50x80, alum., pure white	24	DABA5008019010

DABA5008019010



Coupling, sheet steel

- for mechanical and electrical connection of the profiles

Designation	PU	Order no.
Coupling, kit for DABA50080, sheet steel, galvanized	1	DABA500809VERZ

DABA500809VERZ



Bracket kit, sheet steel

Designation	PU	Order no.
Bracket kit for DABA50080, sheet steel, aluminum white	1	DABA50080109006
Bracket kit for DABA50080, sheet steel, pure white	1	DABA50080109010

DABA50080109010



Ceiling bracket, sheet steel

- DABZAB250XXXX for 250 - 400 mm height range
- DABZAB400XXXX for 400 - 700 mm height range
- DABZAB700XXXX for 700 - 1300 mm height range

Designation	PU	Order no.
Ceiling bracket 250-400 for DAB, sheet steel, aluminum white	1	DABZAB2509006
Ceiling bracket 250-400 for DAB, sheet steel, pure white	1	DABZAB2509010
Ceiling bracket 400-700 for DAB, sheet steel, aluminum white	1	DABZAB4009006
Ceiling bracket 400-700 for DAB, sheet steel, pure white	1	DABZAB4009010
Ceiling bracket 700-1300 for DAB, sheet steel, aluminum white	1	DABZAB7009006
Ceiling bracket 700-1300 for DAB, sheet steel, pure white	1	DABZAB7009010

DABZAB2509010

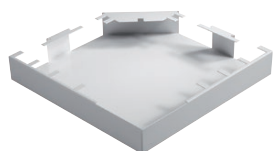

Flat corner, sheet steel

Designation	PU	Order no.
Flat corner for DABA50080, sheet steel, aluminum white	1	DABA5008059006
Flat corner for DABA50080, sheet steel, pure white	1	DABA5008059010

DABA5008059010

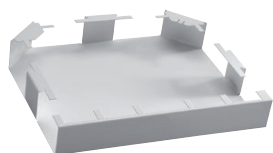

T-piece, sheet steel

Designation	PU	Order no.
T-piece for DABA50080, sheet steel, aluminum white	1	DABA5008079006
T-piece for DABA50080, sheet steel, pure white	1	DABA5008079010

DABA5008079010



End plate, sheet steel

Designation	PU	Order no.
End plate, kit for DABA50080, sheet steel, aluminum white	1	DABA5008069006
End plate, kit for DABA50080, sheet steel, pure white	1	DABA5008069010

DABA5008069010



Wall end piece, sheet steel

Designation	PU	Order no.
Wall end piece, kit f. DABA50080, sheet steel, aluminum white	1	DABA5008089006
Wall end piece, kit f. DABA50080, sheet steel, pure white	1	DABA5008089010

DABA5008089010



Adapter "universal", sheet steel

For fastening lamps and information signs

Designation	PU	Order no.
Adapter "universal" for DAB, sheet steel, aluminum white	1	DABZADUN9006
Adapter "universal" for DAB, sheet steel, pure white	1	DABZADUN9010

DABZADUN9010



Adapter hose, sheet steel

For connecting DA200 pillars with flex technology

Designation	PU	Order no.
Adapter hose for DAB, sheet steel, aluminum white	1	DABZADFLR9006
Adapter hose for DAB, sheet steel, pure white	1	DABZADFLR9010

DABZADFLR9010



Earthing clamp

- for base terminals up to a cross section of 10 mm²

Designation	PU	Order no.
Earthing clamp, chromated	10	L4187CHRO

L4187CHRO



Earthing bracket

Designation	PU	Order no.
Earthing bracket	50	L5800

L5800



Earthing lines

- Pluggable, cross-section 4 mm², for electrical connection of base profile and top parts as well as for bypassing shaped parts

Designation	PU	Order no.
Earthing line, L=150 mm, push-on contact	100	L4181GNGE
Earthing line, L=300 mm, push-on contact	100	L4182GNGE
Earthing line, L=600 mm, push-on contact	25	L4183GNGE

L4181GNGE

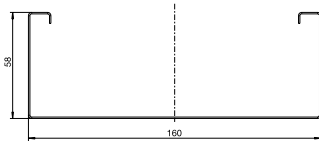

Loading of the usable cross section

- Maximum cable load of DABS501601:
- max. 23 kg/m for a support distance of 1.0 m
- max. 20 kg/m for a support distance of 1.5 m
- Load test was performed based on standard EN 61537 "Cable management. Cable tray systems and cable ladder systems".
- Usable surface of DABS501601: 89 cm² (2 x 44.5 cm²):

- max. number of cables:

- 3 x 1.5 mm²: 124
- 5 x 2.5 mm²: 74
- Cat.6 cables: 140

- Observe maximum cable load
- Observe earthing requirements

Available length

3000 mm

Notes on delivery:

2 m profile need to be ordered per 1 m cable tray

Available colors for DABS

RAL 9010, pure white
RAL 9006, aluminum white



DABS cable tray, sheet steel

Designation	PU	Order no.
Cable tray 50x160, sheet steel, aluminum white	12	DABS5016019006
Cable tray 50x160, sheet steel, pure white	12	DABS5016019010

DABS5016019010

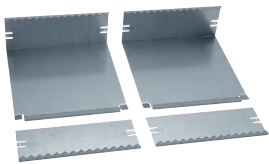

Coupling, sheet steel

- for mechanical and electrical connection of the profiles

Designation	PU	Order no.
Coupling, kit for DABA50080, sheet steel, galvanized	1	DABS501609VERZ

DABS501609VERZ



Bracket kit, sheet steel

Designation	PU	Order no.
Bracket kit for DABS50160, sheet steel, aluminum white	1	DABS50160109006
Bracket kit for DABS50160, sheet steel, pure white	1	DABS50160109010

DABS50160109010



Ceiling bracket, sheet steel

- DABZAB250XXXX for 250 - 400 mm height range
- DABZAB400XXXX for 400 - 700 mm height range
- DABZAB700XXXX for 700 - 1300 mm height range

Designation	PU	Order no.
Ceiling bracket 250-400 for DAB, sheet steel, aluminum white	1	DABZAB2509006
Ceiling bracket 250-400 for DAB, sheet steel, pure white	1	DABZAB2509010
Ceiling bracket 400-700 for DAB, sheet steel, aluminum white	1	DABZAB4009006
Ceiling bracket 400-700 for DAB, sheet steel, pure white	1	DABZAB4009010
Ceiling bracket 700-1300 for DAB, sheet steel, aluminum white	1	DABZAB7009006
Ceiling bracket 700-1300 for DAB, sheet steel, pure white	1	DABZAB7009010

DABZAB2509010



Flat corner, sheet steel

Designation	PU	Order no.
Flat corner for DABS50160, sheet steel, aluminum white	1	DABS5016059006
Flat corner for DABS50160, sheet steel, pure white	1	DABS5016059010

DABS5016059010

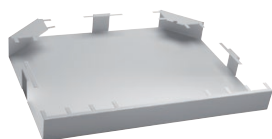

T-piece, sheet steel

Designation	PU	Order no.
T-piece for DABS50160, sheet steel, aluminum white	1	DABS5016079006
T-piece for DABS50160, sheet steel, pure white	1	DABS5016079010

DABS5016079010



End plate, sheet steel

Designation	PU	Order no.
End plate, kit, f. DABS50160, sheet steel, aluminum white	1	DABS5016069006
End plate, kit, f. DABS50160, sheet steel, pure white	1	DABS5016069010

DABS5016069010

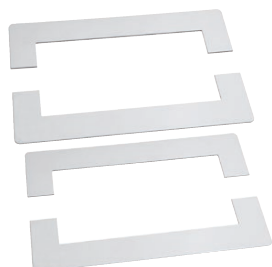

Wall end piece, sheet steel

Designation	PU	Order no.
Wall end piece, kit f. DABS50160, sheet steel, aluminum white	1	DABS5016089006
Wall end piece, kit f. DABS50160, sheet steel, pure white	1	DABS5016089010

DABS5016089010



Adapter "universal", sheet steel

For fastening lamps and information signs

Designation	PU	Order no.
Adapter "universal" for DAB, sheet steel, aluminum white	1	DABZADUN9006
Adapter "universal" for DAB, sheet steel, pure white	1	DABZADUN9010

DABZADUN9010



Adapter hose, sheet steel

For connecting DA200 pillars with flex technology

Designation	PU	Order no.
Adapter hose for DAB, sheet steel, aluminum white	1	DABZADFLR9006
Adapter hose for DAB, sheet steel, pure white	1	DABZADFLR9010

DABZADFLR9010



Potential equalization connector, sheet steel

Designation	PU	Order no.
Potential equalization connector, FWK	20	L6681GCHR

L6681GCHR



Earthing clamp

- for base terminals up to a cross section of 10 mm²

Designation	PU	Order no.
Earthing clamp, chromated	10	L4187CHRO

L4187CHRO



Earthing lines

- Pluggable, cross-section 4 mm², for electrical connection of base profile and top parts as well as for bypassing shaped parts

Designation	PU	Order no.
Earthing line, L=150mm, push-on contact	100	L4181GNGE
Earthing line, L=300mm, push-on contact	100	L4182GNGE
Earthing line, L=600mm, push-on contact	25	L4183GNGE

L4181GNGE

The consolidation point enables a flexible, decentralized connection

- Data connection systems in accordance with EN50173-1:2002
- Energy connections on up to six self-locking input connectors
- Die Gehäuse können beliebig miteinander kombiniert werden
- Can be installed in BRN or BR trunking systems from 170 mm width (except for BRSN), DABS cable tray (sheet steel), BKB floor trunking systems or in suspended ceilings

Scope of delivery
Housing with connecting sockets, copper connections with anti-dust covers

Color
black gray

Material
Impact-resistant plastics made of halogen-free PC/ABS



Consolidation point for Wieland-gesis power connections

with six 3-pin connections for self-wiring

Designation	PU	Order no.
Consolidation point Wieland complete	1	G8366

G8366



Consolidation point for WAGO-WINSTA power connections

Designation	PU	Order no.
Consolidation point WAGO 230V 6x3-pin	1	G8360

G8360



Consolidation point for BTR Cat.6a data connections

E-DAT module Cat.6a 8(8) with BTR insulation displacement connectors (IDC) and anti-dust covers strain relief on module and housing

Designation	PU	Order no.
Consolidation point Cat.6A, RJ45, 6-fold	1	G3160

G3160

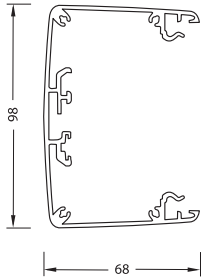

3 variants

- Ceiling-fed service pillar
- with clamping system (C)
- with mounting-bracket system (M)
- with flex system (F)
- Easy and quick unassisted installation possible
- Ceiling-fed service pillar, 1-fold

- RAL 9010 variant with end plates and enclosed ceiling concealer in RAL 9010, pure white
- Special colors on request

Material

- Body: aluminum
- End plates: polyamide / die-cast aluminum
- Clamping mechanism: steel

Device installation

Front-latching device installation with WAGO-WINSTA connection system and modular covers or conventional device installation

General information

Minimum line capacity
6 x ø 12 mm and 4 x ø 8 mm

Available colors

- ELN, naturally-anodized aluminum
- RAL 9010, pure white
- ELN variant with end plates and enclosed ceiling concealer in RAL 7021, anthracite

Note

Lights can be integrated in all DA 200 pillars.



DAS802500ELN

DA 200, 1-fold with clamping system

Slightly curved profile incl. partition wall, preinstalled spirit level, ceiling concealer and earthing accessories.

Note

Specified length range corresponds to height of fixed ceiling. The corresponding maximum height of the intermediate ceiling is the lowest height value minus 50 mm. (See Technical Appendix)

Designation	PU	Order no.
DA200 clamping system 2.5 - 2.8 m naturally anodized	1	DAS802500ELN
DA200 clamping system 2.5 - 2.8 m pure white	1	DAS8025009010
DA200 clamping system 2.8 - 3.1 m naturally anodized	1	DAS802800ELN
DA200 clamping system 2.8 - 3.1 m pure white	1	DAS8028009010
DA200 clamping system 3.1 - 3.4 m naturally anodized	1	DAS803100ELN
DA200 clamping system 3.1 - 3.4 m pure white	1	DAS8031009010
DA200 clamping system 3.4 - 3.7 m naturally anodized	1	DAS803400ELN
DA200 clamping system 3.4 - 3.7 m pure white	1	DAS8034009010



DA 200, 1-fold with mounting-bracket system

Slightly curved profile, incl. mounting bracket, partition wall, preinstalled spirit level, ceiling concealer and earthing accessories.

Note

Specified length corresponds to length of the pillar profile.

Designation	PU	Order no.
DA200 mounting-bracket system 2800 mm, naturally anodized	1	DAK802800ELN
DA200 mounting-bracket system 2800 mm, pure white	1	DAK8028009010
DA200 mounting-bracket system 3400 mm, naturally anodized	1	DAK803400ELN
DA200 mounting-bracket system 3400 mm, pure white	1	DAK8034009010



DAF802000ELN

DA 200, 1-fold with flex system

Slightly curved profile, incl. hose (length 2000 mm, diameter 40 mm), partition wall, ceiling concealer and earthing accessories, without base.

Note

Specified length corresponds to length of the pillar profile.

Designation	PU	Order no.
DA200 with hose 2000 mm, naturally anodized	1	DAF802000ELN
DA200 with hose 2000 mm, pure white	1	DAF8020009010

Available colors

RAL 9010, pure white
LAN, painted, natural
aluminum

Base

RAL 7021, anthracite
RAL 7035, light gray

Material

- Mounting bracket, galvanized sheet steel
- Ceiling concealer polyamide
- Base cast iron

Ceiling concealer

RAL 7021, anthracite
RAL 7035, light gray

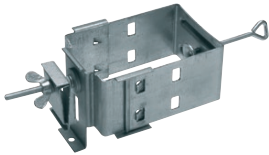

Mounting bracket DA 200, 1-fold, galvanized sheet steel

Designation	PU	Order no.
Mounting bracket complete	1	L5310

L5310



Ceiling concealer DA 200, 1-fold, polyamide

Designation	PU	Order no.
Ceiling concealer DA200 1-fold, painted, natural aluminum	1	DAC80LAN
Ceiling concealer DA200 1-fold, black gray	1	DAC807021
Ceiling concealer DA200 1-fold, light gray	1	DAC807035
Ceiling concealer DA200 1-fold, pure white	1	DAC809010

DAC80ELN



Base for DA 200 with flex system, 1-fold

Cast iron
Weight: 15 kg
Size: 300 x 300 x 26 mm

Designation	PU	Order no.
Base plate DAF, anthracite	1	DAFF20007021
Base plate DAF, light gray	1	DAFF20007035

DAFF20007021

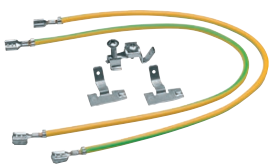

Earthing kit for DA 200

for electrical connections, basic profile/top part

Designation	PU	Order no.
Earthing kit for DA 200	1	L5805

L5805

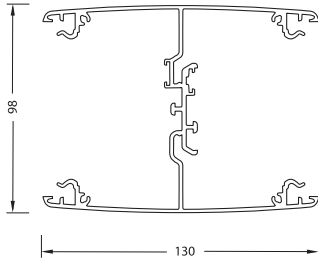

3 variants

- Ceiling-fed service pillar
- with clamping system (C)
- with mounting-bracket system (M)
- with flex system (F)
- Easy and quick unassisted installation possible
- Ceiling-fed service pillar, 2-fold

- ELN variant with end plates and enclosed ceiling concealer in RAL 7021, anthracite
- RAL 9010 variant with end plates and enclosed ceiling concealer in RAL 9010, pure white
- Special colors on request

Device installation

Front-latching device installation with WAGO-WINSTA connection system and modular covers or conventional device installation

Material

- Body: aluminum
- End plates: polyamide / die-cast aluminum
- Clamping mechanism: steel

Available colors

ELN, naturally-anodized aluminum
RAL 9010, pure white

General information

Minimum line capacity
12 x ø 12 mm and 8 x ø 8 mm

Note

Lights can be integrated in all DA 200 pillars



DAS2802500ELN

DA 200, 2-fold with clamping system

Slightly curved profile, partition wall, preinstalled spirit level, ceiling concealer and earthing accessories.

Note

Specified length range corresponds to height of fixed ceiling. See Technical Appendix for corresponding maximum intermediate-ceiling height.

Designation	PU	Order no.
DA200 2-f clamping system 2.5 - 2.8 m naturally anodized	1	DAS2802500ELN
DA200 2-f clamping system 2.5 - 2.8 m pure white	1	DAS28025009010
DA200 2-f clamping system 2.8 - 3.1 m naturally anodized	1	DAS2802800ELN
DA200 2-f clamping system 2.8 - 3.1 m pure white	1	DAS28028009010
DA200 2-f clamping system 3.1 - 3.4 m naturally anodized	1	DAS2803100ELN
DA200 2-f clamping system 3.1 - 3.4 m pure white	1	DAS28031009010
DA200 2-f clamping system 3.4 - 3.7 m naturally anodized	1	DAS2803400ELN
DA200 2-f clamping system 3.4 - 3.7 m pure white	1	DAS28034009010



DAK2802800ELN

DA 200, 2-fold with mounting-bracket system

Slightly curved profile, incl. mounting bracket, partition wall, preinstalled spirit level, ceiling concealer and earthing accessories.

Note

Specified length corresponds to length of the pillar profile.

Designation	PU	Order no.
DA200 2-f mounting-bracket system 2800 mm, naturally anod.	1	DAK2802800ELN
DA200 2-f mounting-bracket system 2800 mm, pure white	1	DAK28028009010
DA200 2-f mounting-bracket system 3400 mm, naturally anod.	1	DAK2803400ELN
DA200 2-f mounting-bracket system 3400 mm, pure white	1	DAK28034009010



DAF2802000ELN

DA 200, 2-fold with flex system

Slightly curved profile, incl. hose (length 2000 mm, diameter 40 mm), partition wall, ceiling concealer and earthing accessories, **without** base.

Note

Specified length corresponds to length of the pillar profile.

Designation	PU	Order no.
DA200 2-f with hose 2000 mm, naturally anod.	1	DAF2802000ELN
DA200 2-f with hose 2000 mm, pure white	1	DAF28020009010

Available colors

LAN, painted, natural aluminum

Base

RAL 7021, anthracite
RAL 7035, light gray

Material

- Mounting bracket, galvanized sheet steel
- Ceiling concealer polyamide
- Base cast iron

Ceiling concealer

RAL 7021, anthracite
RAL 7035, light gray
RAL 9010, pure white

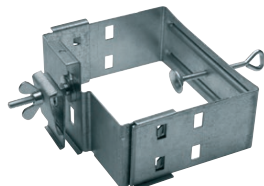

Mounting bracket DA 200, 2-fold, galvanized sheet steel

Designation	PU	Order no.
Mounting bracket double, complete	1	L5320

L5320



Ceiling concealer DA 200, 2-fold, polyamide

Designation	PU	Order no.
Ceiling concealer DA200 2-fold, painted, natural aluminum	1	DAC280LAN
Ceiling concealer DA200 2-fold, black gray	1	DAC2807021
Ceiling concealer DA200 2-fold, light gray	1	DAC2807035
Ceiling concealer DA200 2-fold, pure white	1	DAC2809010

DAC2807021



Base for DA 200 with flex system, 2-fold

Cast iron
Weight: 15 kg
Size: 300 x 340 x 26 mm

Designation	PU	Order no.
Base plate DAF 2-fold, anthracite	1	DAFF220007021
Base plate DAF 2-fold, light gray	1	DAFF220007035

DAFF220007021

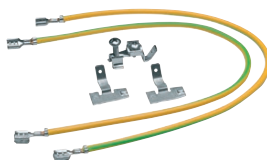

Earthing kit for DA 200

for electrical connections, basic profile/top part

Designation	PU	Order no.
Earthing kit for DA 200	1	L5805

L5805

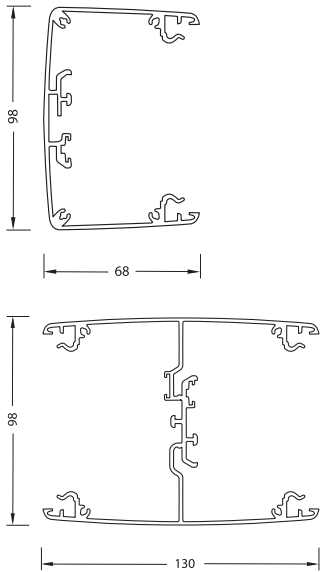

- Service pillar made of DA 200 profile for the distribution of power and data across the entire floor space
- Solid mounting of floor plate to floor
- Underground line infeed

Device installation
 Front-latching device installation with WAGO-WINSTA connection system and modular covers or conventional device installation

- Scope of delivery**
- Top part and base
 - Floor plate
 - Cap
 - Earthing kit

Available colors
 ELN, naturally-anodized aluminum
 RAL 9010, pure white

- ELN variant with floor plate and cap in RAL 7021, anthracite
- RAL 9010 variant with floor plate and cap in RAL 9010, pure white

Material

- Body: aluminum
- Cap: polyamide
- Floor plate: sheet steel

Custom solutions and lengths on request

Note
 Front-latching device installation, see DA 200 pillar system



DAP80650ELN

Floor-fed service pillar, single-sided

Aluminum installation pillar for front-latching installation devices with modular covers, slightly convex profile (68 x 98 mm), floor plate (168 x 138 mm)

Designation	PU	Order no.
Floor-fed service pillar, 650 mm, naturally anod.	1	DAP80650ELN
Floor-fed service pillar, 650 mm, pure white	1	DAP806509010

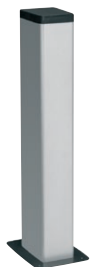

DAP280650ELN

Floor-fed service pillar, double-sided

Aluminum installation pillar for front-latching installation devices with modular covers, slightly convex profile (130 x 98 mm), floor plate (168 x 200 mm)

Designation	PU	Order no.
Floor-fed service pillar, 2-sided, 650 mm, naturally anod.	1	DAP280650ELN
Floor-fed service pillar, 2-sided, 650 mm, pure white	1	DAP2806509010

Lines and connectors

- Input connector and output connector with the WAGO-WINSTA system
- Terminal cross section (spring terminal) 1.5-2.5 mm²
- Two independent clamping points per pole for solid and fine-stranded conductors for the looping-through of lines
- 100% protection against accidental contact and reverse polarity protection

- Test openings accessible in plugged-in condition

Energy bus

Connection kit as phase changer for connecting 5 x 2.5 mm² to 3 x 2.5 mm² with WAGO-WINSTA connection systems

Connecting-line material

Sheathing made of PVC or halogen-free



Input connector

The input connector is required to connect the power socket



Designation	PU	Order no.
Input connector 3-p.	25	G4703

G4703



Output connector

For the connection to further power sockets

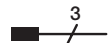

Designation	PU	Order no.
Output connector 3-p.	25	G4713

G4713



H-distributor

For parallel-switching of multiple power sockets

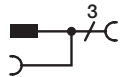

Designation	PU	Order no.
H-distributor 3 p.	10	G4773

G4773

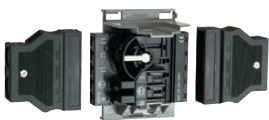

Energy-bus connection kit

Phase changer with two strain relief housings for branch-off from 5-pin to 3-pin lines. Adjustable phase assignment L1, L2, L3.

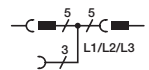

Designation	PU	Order no.
Connection kit energy bus	1	G4700

G4700



G4732

Connecting lines

With input connector and output connector
 - 3 x 1.5 mm²
 - 3 x 2.5 mm²
 - 3 x 2.5 mm halogen-free (hfr)

Designation	PU	Order no.
WAGO conn. line 3x1.5 mm ² , 300 mm	10	G4719
WAGO conn. line 3x1.5 mm ² , 450 mm	10	G4730
WAGO conn. line 3x1.5 mm ² , 750 mm	10	G4732
WAGO conn. line 3x1.5 mm ² , 1500 mm	20	G4735
WAGO conn. line 3x1.5 mm ² , 2500 mm	10	G4736
WAGO conn. line 3x1.5 mm ² , 4500 mm	10	G4740
WAGO conn. line 3x1.5 mm ² , 5000 mm	10	G4745
WAGO conn. line 3x1.5 mm ² , 7500 mm	10	G4746
WAGO conn. line 3x1,5 mm ² , 10000 mm	5	G4749
WAGO conn. line 3x1,5 mm ² , 12500 mm	10	G4750
WAGO conn. line 3x2.5 mm ² , hfr, 300 mm	10	G4733
WAGO conn. line 3x2.5 mm ² , hfr, 450 mm	10	G4743
WAGO conn. line 3x2.5 mm ² , hfr, 750 mm	10	G4753
WAGO conn. line 3x2.5 mm ² , hfr, 1500 mm	10	G4796
WAGO conn. line 3x2.5 mm ² , hfr, 2500 mm	20	G4797
WAGO conn. line 3x2.5 mm ² , hfr, 4500 mm	10	G4798
WAGO conn. line 3x2.5 mm ² , hfr, 5000 mm	10	G4762
WAGO conn. line 3x2.5 mm ² , hfr, 7500 mm	10	G4764
WAGO conn. line 3x2.5 mm ² , hfr, 300 mm	1	G4790
WAGO conn. line 3x2.5 mm ² , hfr, 450 mm	1	G4791
WAGO conn. line 3x2.5 mm ² , hfr, 750 mm	5	G4792
WAGO conn. line 3x2.5 mm ² , hfr, 1500 mm	20	G4793
WAGO conn. line 3x2.5 mm ² , hfr, 2500 mm	10	G4794
WAGO conn. line 3x2.5 mm ² , hfr, 4500 mm	1	G4795

General information on data sockets

- Easy-to-install connection of the 2 to 4-pair data lines AWG 22/24
- Self-adjusting support ring
- EN 55022 and EN50082T1 standards are complied with
- Potential equalization via tab connector terminal

Telephone sockets

- UAE socket category cat.3 8/8 unshielded with 2 x RJ45 sockets
- Transmission performance up to 16 MHz
- Connected via screwed contacts, AWG 26 to AWG 22 cables
- Design according to DIN EN 60603-7, IEC 603-7
- Sockets suitable for 6 and 8-pin connectors

TAE telephone sockets

- TAE telephone socket 3-fold, 3 x 6 NFN, suitable for 1 x telephone (F) and 2 x secondary devices (N)

- TAE telephone socket 3-fold, 2 x 6/6 NFF, suitable for 2 x telephones (F) and 1 x secondary device (N)
- Connected via screwed contacts, AWG 26 to AWG 22 cables
- Sockets suitable for 6-pin connectors according to DIN 41715

Scope of delivery

Without accessory mounting box

Available cover colors

RAL 9010, pure white
RAL 9001, cream white
RAL 7035, light gray
LAN, painted, natural aluminum

Broadband cable/satellite sockets

- Antenna sockets for terrestrial, broadband cable and satellite connection
- As loop-through socket L6654
- As single or stub line socket L6655
- Compatible with digital TV
- Compatible with cable modems
- Compatible with remote power feeding
- With terminals for coaxial cables of up to 6.5 mm line diameter



G2734

Accessory mounting box, front-latching, PA halogen-free

Vertical and horizontal device installation possible
Dimensions: 70 x 71 x 47 mm

Designation	PU	Order no.
FM accessory mounting box, single, frontl.	1	G2734



G2732

Accessory mounting box, front-latching, PA halogen-free

Vertical and horizontal device installation possible. Holds data sockets

Designation	PU	Order no.
Accessory mounting ring, front-latching,	1	G2732

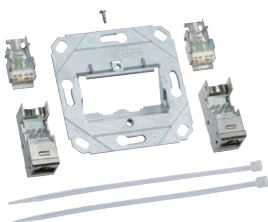

G3150

Data module Cat.6a 8/8 shielded, 2-fold with support ring

- UAE connection module category Cat.6a 8/8 shielded, up to 500 MHz
- individually shielded RJ45 modules 8 (8)
- Tab connector terminal on every module
- Strain relief with tie wrap on module
- DE-EMBEDDED TESTED

Note

Use the screws supplied with the modules for mounting the central plate.

Designation	PU	Order no.
Data module cat.6A, 2-fold with support ring	1	G3150

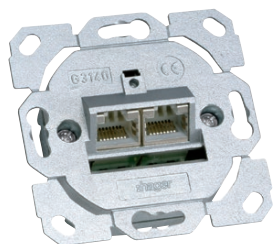

Data socket cat.6a 8/8 shielded, 2-fold with support ring

- UAE socket category cat.6a 8/8 shielded, up to 500 MHz
- LSA-PLUS connection system
- Cable feeding possible from 8 directions
- DE-EMBEDDED TESTED

Designation	PU	Order no.
Data socket cat.6A, 2-fold, 8/8 pin	1	G3140

G3140

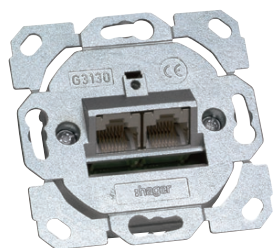

Data socket cat.5e 8/8 shielded, 2-fold with support ring

- UAE socket category cat.5e 8/8 shielded, up to 100 MHz
- LSA-PLUS connection system
- Cable feeding possible from 8 directions

Designation	PU	Order no.
Data socket cat.5e, 2-fold, 8/8 pin	1	G3130

G3130



Modular cover 2 x RJ45, PVC and PC/ABS halogen-free (hfr)

Designation	PU	Order no.
Cover 2 x RJ45, 80 mm, light gray	1	G32247035
Cover 2 x RJ45, 80 mm, cream white	1	G32249001
Cover 2 x RJ45, 80 mm, pure white	1	G32249010
Cover 2 x RJ45, 80 mm, hfr, painted aluminum	1	G3234LAN
Cover 2 x RJ45, 80 mm, hfr, light gray	1	G32347035
Cover 2 x RJ45, 80 mm, hfr, cream white	1	G32349001
Cover 2 x RJ45, 80 mm, hfr, pure white	1	G32349010

G32249010



UAE telephone socket

- Cat.3 unshielded
- For connecting 2 x RJ45 connectors, ISDN and DSL-capable

Designation	PU	Order no.
UAE socket 2-fold, 8/8 pin	1	G3120

G3120



Modular cover 2 x RJ45, PVC and PC/ABS halogen-free (hfr)

Designation	PU	Order no.
Cover 2 x RJ45, 80 mm, light gray	1	G32247035
Cover 2 x RJ45, 80 mm, cream white	1	G32249001
Cover 2 x RJ45, 80 mm, pure white	1	G32249010
Cover 2 x RJ45, 80 mm, hfr, painted aluminum	1	G3234LAN
Cover 2 x RJ45, 80 mm, hfr, light gray	1	G32347035
Cover 2 x RJ45, 80 mm, hfr, cream white	1	G32349001
Cover 2 x RJ45, 80 mm, hfr, pure white	1	G32349010

G32249010

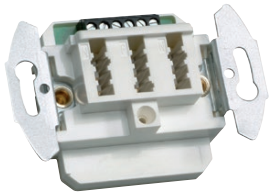

TAE telephone socket

G3100

- TAE 3 x 6 NFN
- one telephone, two secondary devices

G3110

- TAE 2 x 6/6 NFF
- two telephones, one secondary device

G3100

Designation	PU	Order no.
TAE socket 3-fold 3x6 NFN	10	G3100
TAE socket 3-fold, 2x6/6 NFF	10	G3110



Modular cover TAE/TDO, PVC and PC/ABS halogen-free (hfr)

G32049010

Designation	PU	Order no.
Cover TAE/TDO, 80 mm, light gray	1	G32047035
Cover TAE/TDO, 80 mm, cream white	1	G32049001
Cover TAE/TDO, 80 mm, pure white	1	G32049010
Cover TAE/TDO, 80 mm, hfr, painted aluminum	1	G3214LAN
Cover TAE/TDO, 80 mm, hfr, light gray	1	G32147035
Cover TAE/TDO, 80 mm, hfr, cream white	1	G32149001
Cover TAE/TDO, 80 mm, hfr, pure white	1	G32149010

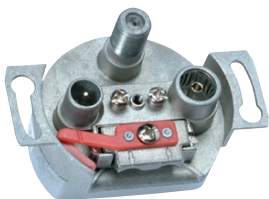

Broadband cable/satellite socket

L6654

- Antenna socket 3-fold, loop-through socket
- Tap loss at 862 MHz: 10 dB
- Tap loss at 2150 MHz: 10 dB
- Through loss 1.5 ... 5 dB
- DC passage

L6655

- Antenna socket 3-fold, terminated
- Tap loss at 862 MHz: 5 dB
- Tap loss at 2150 MHz: 2 dB
- DC passage

L6654

Designation	PU	Order no.
Antenna socket 3-fold, loop-through socket	1	L6654
Antenna socket 3-fold, terminated socket	1	L6655

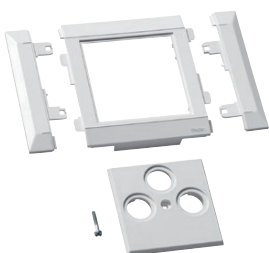

Modular cover 3-fold, PVC and PC/ABS halogen-free (hfr)

G32449010

Designation	PU	Order no.
Antenna cover 3-f, 80 mm, light gray	1	G32447035
Antenna cover 3-f, 80 mm, cream white	1	G32449001
Antenna cover 3-f, 80 mm, pure white	1	G32449010
Antenna cover 3-f, 80 mm, painted aluminum	1	G3254LAN
Antenna cover 3-f, 80 mm, hfr, light gray	1	G32547035
Antenna cover 3-f, 80 mm, hfr, cream white	1	G32549001
Antenna cover 3-f, 80 mm, hfr, pure white	1	G32549010



G35519010

Interim cover piece, PVC and PC/ABS halogen-free (hfr)

- Conceals trim lines and can be mounted side by side
- Interim cover piece is required when power and data sockets are combined with modular covers mounted side by side. In the case of two sockets with separate circuits, two interim cover pieces are connected (the inner tabs are shortened slightly)

Width: 10 mm

Designation	PU	Order no.
Interim piece, mod. cover, 80, lg	10	G35517035
Interim piece, mod. cover, 80, cw	10	G35519001
Interim piece, mod. cover, 80, pw	10	G35519010
Interim piece, mod. cover, 80, hfr, p. alum.	1	G3561LAN
Interim piece, mod. cover, 80, hfr, lg	10	G35617035
Interim piece, mod. cover, 80, hfr, cw	10	G35619001
Interim piece, mod. cover, 80, hfr, pw	10	G35619010

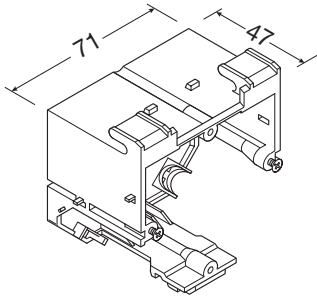

- Accessory mounting box for installing conventional phone and data sockets with 50 x 50 mm central plate
- Vertical or horizontal installation possible
- Strain relief with tie wrap on housing

Available colors for modular cover

- RAL 9010, pure white
- RAL 9001, cream white
- RAL 7035, light gray LAN, painted, natural aluminum

Material

PA halogen-free

Delivery

Accessory mounting box with two device locking screws



G2734

Accessory mounting box, front-latching, PA halogen-free

Vertical and horizontal device installation possible
Dimensions: 70 x 71 x 47 mm

Designation	PU	Order no.
FM accessory mounting box, single, frontl.	1	G2734



G2732

Accessory mounting ring, front-latching, PA halogen-free

Vertical and horizontal device installation possible. Holds data sockets

Designation	PU	Order no.
Accessory mounting ring, front-latching,	1	G2732



G2739

Accessory mounting kit for mini switches front-latching, PA halogen-free

e. g. by WizLAN, Telegärtner or DAFÜR

Designation	PU	Order no.
Accessory mounting kit for mini switches front-latching	1	G2739



G34269010

Modular cover, PVC and PC/ABS halogen-free (hfr)

For installing devices by other manufacturers with 50 x 50 mm central plate with height adjustment for combination with other modular covers.

Designation	PU	Order no.
Cover mod., central plate 50x50, 80, lg	1	G34267035
Cover mod., central plate 50x50, 80, cw	1	G34269001
Cover mod., central plate 50x50, 80, rw	1	G34269010
Cover mod., central plate 50x50, 80, hfr, al. p.	1	G3436LAN
Cover mod., central plate 50x50, 80, hfr, lg	1	G34367035
Cover mod., central plate 50x50, 80, hfr, cw	1	G34369001
Cover mod., central plate 50x50, 80, hfr, pw	1	G34369010

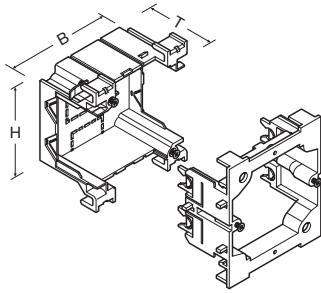

All inserts can be combined with:
- kallysto®.pur frame

Features

- QuickConnect system up to 2.5 mm²
- 10AX: X = rated current for fluorescent lamps
- Standards: VDE 0632, ICE 60669

Advantages

- LED illumination retrofittable without having to dismantle the switch
- Front-check testing contacts: Measuring/testing contacts on front side are accessible in installed condition
- Completely immersed fastening clamps with return spring
- Hager IsoSafe: no conductive connection to metal support ring

- Stable and compact design for quick and easy assembly

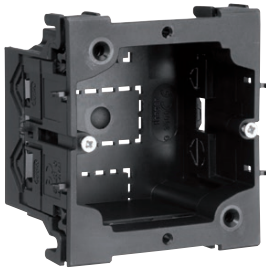

G2700

Accessory mounting box, 1-fold, front-latching, PA halogen-free

Dimensions: 64 x 71 x 42 mm

Designation	PU	Order no.
Accessory mounting box, 1-fold, frontl.	1	G2700

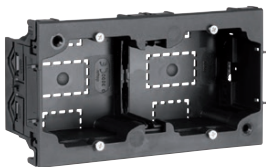

G2705

Accessory mounting box, 2-fold, front-latching, PA halogen-free

Dimensions: 64 x 142 x 42 mm

Designation	PU	Order no.
Accessory mounting box, 2-fold, frontl.	1	G2705

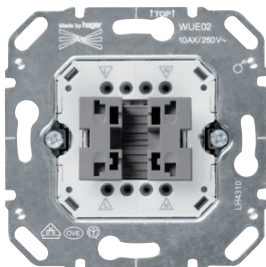

WUE02

Rocker-switch insert

Features:

- 10 AX, 250 V AC; for WUE03: 10 AX, 400 V AC
- Can be illuminated with LED lamps, see "Accessories for flush-mounted inserts"

Normally closed rocker switch:

WYA06x (x: 0 = brilliant white, 1 = cream, 6 = silver, 7 = anthracite)

Series rocker switch

WYA05x (x: 0 = brilliant white, 1 = cream, 6 = silver, 7 = anthracite)

Designation	PU	Order no.
2-pole on-off switch	5	WUE02
3-pole on-off switch	5	WUE03
Series switch	10	WUE05
SPDT changeover switch	10	WUE06
Intermediate switch	10	WUE07
DPDT changeover switch	5	WUE16

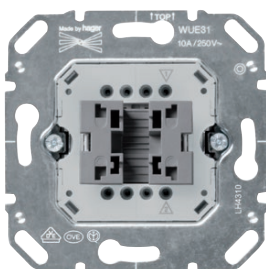

WUE31

Push-button rocker switch insert, 1-pole

Features:

- 10 A, 250 V AC
- Can be illuminated with LED lamps, see "Accessories for flush-mounted inserts"

Normally closed rocker switch:

WYA06x (x: 0 = brilliant white, 1 = cream, 6 = silver, 7 = anthracite)

Designation	PU	Order no.
Push button, NO switch	10	WUE31
Push button, change-over switch with N terminal	10	WUE38

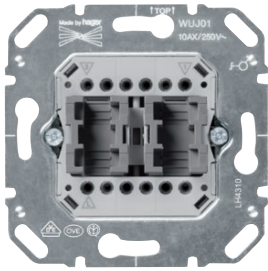

WUJ01

Blinds switch insert

Features:

- 10 A, 250 V AC
 - Mechanical and electrical locking
 - Suitable for controlling AC and DC drives
- Note: Observe motor manufacturers specifications.

Blinds rocker switch:

WYA12x (x: 0 = brilliant white, 1 = cream, 6 = silver, 7 = anthracite)

Designation	PU	Order no.
Blinds switch, 1-pole	10	WUJ01

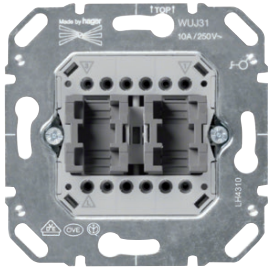

WUJ31

Blinds push button insert

Features:

- 10 A, 250 V AC
 - Mechanical and electrical locking
 - Suitable for controlling AC and DC drives
- Note: Observe motor manufacturers specifications.

Blinds rocker switch:

WYA12x (x: 0 = brilliant white, 1 = cream, 6 = silver, 7 = anthracite)

Designation	PU	Order no.
Blinds switch, 1-pole	10	WUJ31



WYA060

Normally closed rocker

Features:

- Material: Thermoplastic
- As cover for flush-mounted inserts:
On-off switches, 2-pole and 3-pole, change-over switches, intermediate switches and push buttons

Designation	PU	Order no.
Rocker, NC, f. switch, push button, bwhite	10	WYA060
Rocker, NC, f. switch, push button, cream	10	WYA061
Rocker, NC, f. switch, push button, silver	10	WYA066
Rocker, NC, f. switch, push button, anth	10	WYA067



WYA050

Series rocker

Features:

- Material: Thermoplastic
- As cover for flush-mounted inserts:
- Series switches, DPDT changeover switches, series push buttons, blinds push buttons

Designation	PU	Order no.
Series rocker, series switch/push button, bwhite	10	WYA050
Series rocker, series switch/push button, cream	10	WYA051
Series rocker, series switch/push button, silver	10	WYA056
Series rocker, series switch/push button, anth	10	WYA057



WYA120

Series rocker blinds switch with arrow symbols

Features:

- Material: Thermoplastic
- As cover for flush-mounted inserts:
- Blinds switch, blinds push button

Designation	PU	Order no.
Rocker blinds switch, arrow symb., bwhite	10	WYA120
Rocker blinds switch, arrow symb., cream	10	WYA121
Rocker blinds switch, arrow symb., silver	10	WYA126
Rocker blinds switch, arrow symb., anth	10	WYA127



WYS400

SCHUKO® socket with increased protection against accidental contact

Features:

- 16 A, 250 V AC
- Increased protection against accidental contact according to DIN VDE 0620 Part 1 (replaces the term "child protection")

Designation	PU	Order no.
Power socket, with protection against accidental contact, beige white	10	WYS400
Power socket, with protection against accidental contact, cream white	10	WYS401
Power socket, with protection against accidental contact, silver	10	WYS406
Power socket, with protection against accidental contact, anthracite	10	WYS407



WYS220

Power socket SCHUKO® 45°

Features:

- 16 A, 250 V AC
- Suitable for use with e. g. angled connectors

Designation	PU	Order no.
Power socket 45°, brilliant white	10	WYS220
Power socket 45°, cream	10	WYS221
Power socket 45°, silver	10	WYS226
Power socket 45°, anthracite	10	WYS227



WYR110

kallysto.pur, 1-fold frame

Features:

- Material: Thermoplastic
- For vertical and horizontal assembly

Designation	PU	Order no.
1-fold frame PUR, brilliant white	10	WYR110
1-fold frame PUR, cream	10	WYR111
1-fold frame PUR, silver	10	WYR116
1-fold frame PUR, anthracite	10	WYR117



WYR120

kallysto.pur, 2-fold frame

Features:

- Material: Thermoplastic
- For vertical and horizontal assembly

Designation	PU	Order no.
2-fold frame PUR, brilliant white	10	WYR120
2-fold frame PUR, cream	10	WYR121
2-fold frame PUR, silver	10	WYR126
2-fold frame PUR, anthracite	10	WYR127



WYR130

kallysto.pur, 3-fold frame

- Material: Thermoplastic
- For vertical and horizontal assembly

Designation	PU	Order no.
3-fold frame PUR, brilliant white	5	WYR130
3-fold frame PUR, cream	5	WYR131
3-fold frame PUR, silver	5	WYR136
3-fold frame PUR, anthracite	5	WYR137

Accessory mounting box for CEE devices up to 32 A, front-latching

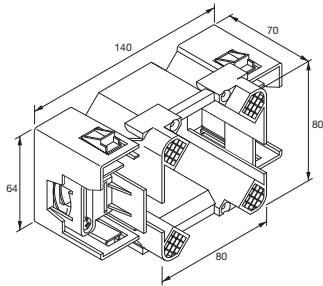

Large stable plastic housing for installation in trunking systems with front-latching device installation (BRS/BRSN) and DA200 pillar system for CEE accessory mounting boxes by various manufacturers. (See Technical Appendix)

Available colors of cover kit
RAL 9010, pure white LAN, painted, natural aluminum

Scope of supply
Mounting box, 4 device locking screws, 2 strain reliefs



CEE accessory mounting box, front-latching, PA halogen-free

incl. 4 device locking screws and 2 strain reliefs

Designation	PU	Order no.
Accessory mounting box, CEE, front-latching	1	G2745

G2745



Cover kit DA200 for device installation CEE, PC/ABS halogen-free (hfr)

Designation	PU	Order no.
Cover kit DA200 device installation CEE, painted, natural aluminum	1	G3375LAN
Cover kit DA200 device installation CEE, pure white	1	G33759010

G33759010

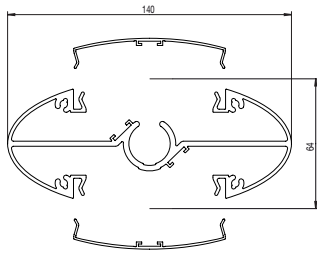

- with clamping system
 - with flex system
 - Attractively shaped, elliptic profile providing installation positions on both sides for preassembled device installation modules with 5 SCHUKO power sockets and 4 Cat.6 STP data ports
 - Body: aluminum
 - Device installation module, ceiling concealer and plastic head
 - Base profile made of aluminum, black anodized
- Device installation module, head and fabric hose RAL 9011, graphite black
 - Ceiling concealer and design feature of device installation module painted in titanium gray



DES2700D

Design service pillar with clamping system

- Elliptic profile incl. clamping mechanism, preinstalled spirit level, ceiling concealer and earthing accessories
- Prefitted with pre-wired device installation module with 5 SCHUKO power sockets and 4 Cat.6 STP data ports, line length from module 6.5 m

Note

Specified length range corresponds to height of fixed ceiling. The corresponding maximum height of the intermediate ceiling is the lowest height value minus 60 mm

Designation	PU	Order no.
Design service pillar, 2.7-3.0 m, 4xCat.6, 5xSTD	1	DES2700D
Design service pillar, 3.0-3.3 m, 4xCat.6, 5xSTD	1	DES3000D
Design service pillar, 3.3-3.6 m, 4xCat.6, 5xSTD	1	DES3300D



DEF2000D

- Without base
- Elliptic profile incl. ceiling concealer, fabric hose 2 m and earthing accessories
- Prefitted with pre-wired device installation module with 5 SCHUKO® power sockets and 4 Cat.6 STP data ports, line length from module 6.5 m

Note

Specified length corresponds to length of the pillar profile

Designation	PU	Order no.
Design service pillar, 2.0 m, 4xCat.6, 5xSTD	1	



DEFF

Base for design service pillar with flex technology

- Cast iron
- Outer diameter: 445 mm
- Weight: 15 kg
- Available color: RAL 9011, graphite black

Designation	PU	Order no.
Base for design service pillar flex, black	1	DEFF



DEM D

Device installation module for DES/DEF design service pillars

- For device installation on both sides of the service pillar or as spare part
- Prefitted with 5 SCHUKO® power sockets and 4 Cat.6 STP data ports
- Prewired with 6.5 m line length
- Preassembled lines with WAGO-WINSTA and RJ45 connector technology

Designation	PU	Order no.
Preass. module f. DEF/DES 4xCat.6, 5xSTD	1	DEM D

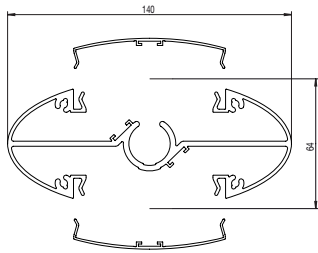

- Attractively shaped, elliptic profile providing installation positions on both sides for preassembled device installation modules with 5 SCHUKO® power sockets and 4 Cat.6 STP data ports
- Height 650 mm
- Attachment: Service pillar base screws to double floor or cavity floor

- 2 earthing kits L5805 and assembly kit (4 screws, 4 plugs) included in scope of supply.

Material

- Body: aluminum
- Device installation module made of plastic
- Service pillar cap and base made of steel

Available colors

- Base profile made of aluminum, black anodized
- Device installation module, RAL 9011, graphite black
- Design element of device installation module painted in titanium gray



DEP650D

Floor-fed service pillar „exklusiv“ DEP

- Elliptic profile
- Prefitted with pre-wired device installation module with 5 SCHUKO® power sockets and 4 Cat.6 STP data ports, line length from module 3.5 m
- Height 650 mm

Designation	PU	Order no.
Design service pillar, 0.65 m, 4xCat.6, 5xSTD	1	DEP650D







DEPMD

Device installation module for DEP design service pillar

- For device installation on both sides of the design service pillar or as spare part
- Prefitted with 5 SCHUKO® power sockets and 4 Cat.6 STP data ports
- Prewired with 3.5 m line length
- Preassembled lines with WAGO-WINSTA and RJ45 connector technology

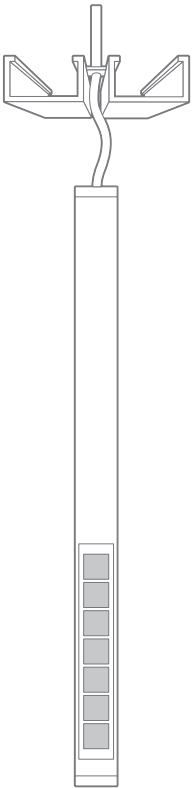
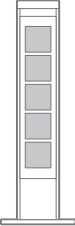
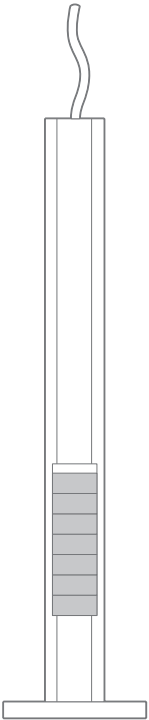
Designation	PU	Order no.
Preass. module f. for 4xCat.6 – 5xSTD	1	DEPMD

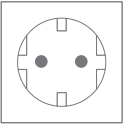
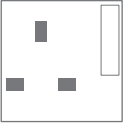
Compatibility selection guide with socket outlets

	 tehalit.DA	 tehalit.DAP	 tehalit.DE	 tehalit.DEP
Schuko socket outlet 	●	●	●	●
British Standard socket outlet 	●	●	-	-
45 x 45 socket outlet 	●	●	●	●

Hager Vertriebsgesellschaft mbH & Co. KG
Zum Gunterstal
66440 Blieskastel
Germany
Phone: +49 (0)6842 945 0

Hager Electro S.A.S.
132 Boulevard d'Europe
B.P. 3
67215 Obernai cedex
France
Phone: +33 (0)3 88 49 50 50
Fax: +33 (0)3 88 49 51 44
www.hager.com

